

# TOSHIBA



# Operating Guide

## Integrated High Definition DLP™ Projection Television

COLOR STREAM® HD THEATER WIDE HD  
DOLBY DIGITAL SRS WOW HDMI HDTV HIGH DEFINITION TELEVISION

## 50HM66

## 56HM66

### IMPORTANT NOTE

Before connecting, operating, or adjusting this product, carefully read the Important Safety, Installation, Care, and Service information in the *Installation Guide*.

For an overview of steps for setting up your new TV, see page 4.

Note: To display a High Definition picture, the TV must be receiving a High Definition signal (such as an over-the-air High Definition TV broadcast, a High Definition digital cable program, or a High Definition digital satellite program). For details, please contact your TV antenna installer, cable provider, or satellite provider.

Note: If the TV is powered off and then quickly on again when the lamp unit is hot, it may take several minutes for the picture to appear on-screen. This is a property of DLP™ TV lamp technology and is NOT a sign of malfunction. For details, see "IMPORTANT NOTICE ABOUT HOT LAMP RESTART" on page 2.



### Owner's Record

The model number and serial number are on the back of your TV. Record these numbers in the spaces below. Refer to these numbers whenever you communicate with your Toshiba dealer about this TV.

Model number:

Serial number:



**CAUTION:** This television is for use only with the Toshiba stand indicated below. Use with other carts or stands is capable of resulting in instability, causing possible injury.

Television	Stand Model
50HM66	ST5066
56HM66	ST5666

## Welcome to Toshiba

Thank you for purchasing this Toshiba TV, one of the most innovative DLP™ projection TVs on the market. We have provided two separate guides to facilitate the installation and operation of your TV.

**Please use the Guides in the order shown below to get the most enjoyment from your new TV.**

- The “*Installation Guide*” explains how to connect your TV to your antenna and equipment.
- The “*Operating Guide*” (this Guide) provides step-by-step instructions for using your TV’s many features.

## Important notes about your DLP™ projection TV

- 1) The light source for this TV is a projection lamp unit with a limited service life. When the lamp wears out, the picture may become dark or black or the lamp may fail, at which time you must replace the lamp unit. See “Lamp unit replacement and care” (☞ pages 47–49).
- 2) When the lamp mode is set to **Low Power**, every time the TV is powered on, the lamp will initially be in **High Bright** mode but will switch to **Low Power** mode after a short period of time. You may notice a change in screen brightness when this happens. This is normal and is not a sign of malfunction. (☞ page 42 for details.)
- 3) Every time the TV is powered on, it may take several minutes for the picture to obtain full brightness (☞ IMPORTANT NOTICE ABOUT “HOT LAMP RESTART,” at right).
- 4) The TV’s display is manufactured using an extremely high level of precision technology; however, an occasional pixel (dot of light) may show constantly on the screen. This is a structural property of DLP™ (Digital Light Processing™) technology and is not a sign of malfunction. Such pixels are not visible when the picture is viewed from a normal viewing distance.
- 5) Always sit approximately 10–25 feet away from the TV and as directly in front of it as possible. The picture quality may be affected by your viewing position and length of viewing time. If you sit too closely to the TV for too long, you may suffer from eye fatigue. See item 29 of the “care” information in the separate *Installation Guide*.
- 6) Depending on the media you are viewing, it is possible, although unlikely, that a limited number of viewers may see a “rainbow effect” on the screen, which can, in rare instances, result in eye fatigue. This is a rare occurrence related to DLP technology and is not a sign of TV malfunction.

- 7) This TV contains several cooling fans to moderate the internal temperature. You may be able to hear the fans for several minutes after the TV is turned off. This is a function of the Quick Restart™ feature and is not a sign of TV malfunction. You can set the Quick Restart™ feature to stop the fans as soon as the TV is powered off. See “Setting the Quick Restart™ feature” (☞ page 20).
- 8) The yellow and blue LED lights at the bottom center of the TV front indicate your TV’s current status. If either light flashes, see “LED indications” (☞ page 46).
- 9) Every time the TV power cord is plugged in, the yellow LED will blink until the TV enters standby mode (plugged in but not powered on). This is normal and is not a sign of malfunction.

### “Voice announce” feature

When certain non-standard conditions occur, the LEDs on the TV will blink and the TV will play a recorded “voice announcement” describing the condition (see the LED indication table on page 46 for the specific conditions that include a voice announcement). To repeat the voice announcement and hear additional information, press the MENU button on the TV while the LEDs are blinking.

### IMPORTANT NOTICE ABOUT “HOT LAMP RESTART”

When the TV has been powered on long enough for the lamp unit to get hot, it may take several minutes for the picture to appear on-screen in the following situations:

- When the Quick Restart™ feature is set to **OFF** and you turn the TV off and then on again within a few minutes; or
- If the TV is on when a short-term power failure, power surge, or other similar power failure occurs, such that the TV loses and regains power within a few minutes.

**This is a property of DLP TV lamp technology and is NOT a sign of malfunction.**

If this occurs, the yellow LED on the TV front panel will blink (and the blue LED will be lit solid) until the TV is finished restarting the lamp and the normal picture appears. If both LEDs are blinking, you will need to turn the TV off and then on again to restart the lamp.

## Trademark Information

- This product incorporates copyright protection technology that is protected by U.S. patents and other intellectual property rights. Use of this copyright protection technology must be authorized by Macrovision, and is intended for home and other limited viewing uses only unless otherwise authorized by Macrovision. Reverse engineering or disassembly is prohibited.
- WOW, SRS and ● symbol are trademarks of SRS Labs, Inc. WOW technology is incorporated under license from SRS Labs, Inc.
- \*Manufactured under license from Dolby Laboratories. Dolby and the double-D symbol are registered trademarks of Dolby Laboratories.
- CableCARD™ is a trademark of Cable Television Laboratories, Inc.
- HDMI, the HDMI logo and High-Definition Multimedia Interface are trademarks or registered trademarks of HDMI Licensing LLC.
- Digital Light Processing™, DLP™ and the DLP™ medallion are trademarks of Texas Instruments.

# Contents

<b>Chapter 1: Introduction</b> . . . . .	<b>4</b>	Adjusting the audio quality . . . . .	33
Features of your new TV . . . . .	4	Using the StableSound® feature . . . . .	34
Overview of steps for installing, setting up, and using your new TV . . . . .	4	Turning off the built-in speakers . . . . .	34
TV front and side panel controls and connections . . . . .	5	Selecting the optical audio output format . . . . .	34
TV back panel connections . . . . .	6	Using the Locks menu . . . . .	35
<b>Chapter 2: Using the remote control</b> . . . . .	<b>7</b>	Entering the PIN code . . . . .	35
Preparing the remote control for use . . . . .	7	If you cannot remember your PIN code . . . . .	35
Installing the remote control batteries . . . . .	7	Changing your PIN code . . . . .	35
Remote control effective range . . . . .	7	Blocking TV programs and movies by rating (V-Chip) . . . . .	36
Learning about the remote control . . . . .	8	Blocking channels . . . . .	37
Using the remote control to control your other devices . . . . .	9	Unlocking programs temporarily . . . . .	38
Remote Control functional key chart . . . . .	10	Using the input lock feature . . . . .	38
Programming the remote control to control your other devices . . . . .	11	Using the control panel lock feature . . . . .	39
Remote control codes . . . . .	12	Setting the sleep timer . . . . .	39
<b>Chapter 3: Menu layout and navigation</b> . . . . .	<b>14</b>	Displaying TV setting information on-screen using RECALL . . . . .	40
Main menu layout . . . . .	14	Understanding the auto power off feature . . . . .	40
Setup/Installation menu layout . . . . .	15	Understanding the last mode memory feature . . . . .	40
Navigating the menu system . . . . .	15	<b>Chapter 6: Using the TV's advanced features</b> . . . . .	<b>41</b>
<b>Chapter 4: Setting up your TV</b> . . . . .	<b>16</b>	Using the advanced picture settings features . . . . .	41
Selecting the menu language . . . . .	16	Using dynamic contrast . . . . .	41
Configuring the antenna input sources for the ANT 1 and ANT 2 terminals . . . . .	16	Using CableClear®/DNR (digital noise reduction) . . . . .	41
Programming channels into the TV's channel memory . . . . .	17	Using MPEG noise reduction . . . . .	41
Programming channels automatically . . . . .	17	Selecting the color temperature . . . . .	42
Manually adding and deleting channels in the channel memory . . . . .	17	Selecting the lamp mode . . . . .	42
Programming your favorite channels . . . . .	18	Using the Game Mode feature . . . . .	43
Setting the ColorStream HD audio mode . . . . .	20	Using the advanced audio settings features . . . . .	43
Setting the HDMI™ audio mode . . . . .	20	Using the SRS WOW™ surround sound feature . . . . .	43
Viewing the CableCARD™ menu . . . . .	20	<b>Chapter 7: Troubleshooting</b> . . . . .	<b>44</b>
Setting the Quick Restart™ feature . . . . .	20	General troubleshooting . . . . .	44
Viewing the digital signal meter . . . . .	21	LED indications . . . . .	46
Viewing the system status . . . . .	22	<b>Chapter 8: Appendix</b> . . . . .	<b>47</b>
<b>Chapter 5: Using the TV's basic features</b> . . . . .	<b>23</b>	Lamp unit replacement and care . . . . .	47
Selecting the video input source to view . . . . .	23	Replacing the lamp unit (User-replaceable component) . . . . .	47
Labeling the video input sources . . . . .	23	When to replace the lamp unit . . . . .	47
Tuning channels . . . . .	24	How to replace the lamp unit . . . . .	48
Using the Channel Browser™ . . . . .	24	Disposing of the used lamp unit . . . . .	49
Tuning your favorite channels . . . . .	26	Specifications . . . . .	50
Tuning to the next programmed channel . . . . .	26	Limited United States Warranty for DLP™ Television Models . . . . .	51
Tuning to a specific channel (programmed or unprogrammed) . . . . .	26	Limited Canada Warranty for DLP™ Television Models . . . . .	52
Switching between two channels using Channel Return . . . . .	26	<b>Index</b> . . . . .	<b>54</b>
Switching between two channels using SurfLock™ . . . . .	26		
Selecting the picture size . . . . .	27		
Scrolling the TheaterWide® picture (TheaterWide 2 and 3 only) . . . . .	28		
Using the auto aspect ratio feature . . . . .	29		
Selecting the cinema mode (480i signals only) . . . . .	29		
Adjusting the picture . . . . .	30		
Selecting the picture mode . . . . .	30		
Adjusting the picture quality . . . . .	30		
Using the closed caption mode . . . . .	31		
Closed Caption Advanced . . . . .	31		
Digital closed captions . . . . .	32		
Adjusting the audio . . . . .	32		
Muting the sound . . . . .	32		
Using the digital audio selector . . . . .	32		
Selecting stereo/SAP broadcasts . . . . .	33		

## Chapter 1: Introduction



**NOTICE OF POSSIBLE TV STAND INSTABILITY  
DANGER: RISK OF SERIOUS PERSONAL  
INJURY OR DEATH!** Use this TV only with  
the TOSHIBA TV stand listed in the  
“Specifications” section of this manual. Use with other  
stands may result in instability, causing possible injury or  
death.

**CAUTION:** This television is for use only with the Toshiba  
stand indicated below. Use with other carts or stands is  
capable of resulting in instability, causing possible injury.

Television	Stand Model
50HM66	ST5066
56HM66	ST5666

### Features of your new TV

The following are just a few of the many exciting features of  
your new Toshiba widescreen, integrated HD, DLP™  
projection TV:

- **Integrated digital tuning (8VSB ATSC and QAM)**  
eliminates the need for a separate digital converter set-top  
box (in most cases).
- **Digital CableCARD™ slot** for viewing encrypted digital  
Cable TV programs (☞ *Installation Guide*).
- **Two HDMI™ digital, high-definition multimedia**  
interfaces (☞ *Installation Guide*).
- **Two sets of ColorStream® HD** high-resolution component  
video inputs (☞ *Installation Guide*).
- **SRS WOW™** (☞ page 43), audio technologies.
- **Digital Audio Out** optical audio connection with Dolby®  
Digital optical output format (☞ page 34; also see  
*Installation Guide*).
- **CableClear® DNR** digital picture noise reduction  
(☞ page 41).

#### “Voice announce” feature

When certain non-standard conditions occur, the LEDs on  
the TV will blink and the TV will play a recorded  
“voice announcement” describing the condition (see the  
LED indication table on page 46 for the specific conditions  
that include a voice announcement).  
To repeat the voice announcement and hear additional  
information, press the MENU button on the TV while the  
LEDs are blinking.

### Overview of steps for installing, setting up, and using your new TV

Follow these steps to set up your TV and begin using its many  
exciting features.

- 1 Carefully read the important safety, installation, care, and  
service information in the separate *Installation Guide*.  
Keep this manual for future reference.
- 2 Observe the following when choosing a location for the  
TV:
  - Read the separate *Installation Guide*.
  - Read “Important notes about your DLP™ projection  
TV” (☞ page 2).
  - Place the TV on the applicable optional TV stand listed  
in the “Specifications” section (if available for this TV  
model) or on a sturdy, level, stable surface that can  
safely support the size and weight of the unit.
  - Place the TV in a location where light does not reflect  
on the screen.
  - Place the TV far enough from walls and other objects to  
allow proper ventilation. Inadequate ventilation may  
cause overheating, which will damage the TV. **THIS  
TYPE OF DAMAGE IS NOT COVERED UNDER  
THE TOSHIBA WARRANTY.**
- 3 Do not plug in any power cords until AFTER you have  
connected all cables and devices to your TV.
- 4 BEFORE connecting cables or devices to the TV, learn  
the functions of the TV’s connections and controls  
(☞ pages 5-6).
- 5 Connect your other electronic device(s) to the TV  
(☞ *Installation Guide*).
- 6 Install the batteries in the remote control (☞ page 7).
- 7 See “Learning about the remote control” (☞ page 8) for  
an overview of the buttons on the remote control.
- 8 Program the remote control to operate your other  
device(s) (☞ pages 9-13).
- 9 AFTER connecting all cables and devices, plug in the  
power cords for your TV and other devices.
- 10 **After you plug in the TV power cord, the yellow LED  
(on the TV front ) will blink 3 times.** Wait several  
seconds until the yellow LED stops blinking and then  
press **POWER** on the TV or remote control.  
See “LED indications” (☞ page 46).
- 11 See “Menu layout and navigation” for a quick overview of  
navigating the TV’s menu system (☞ page 14).
- 12 Program channels into the TV’s channel memory  
(☞ page 17).
- 13 For details on using the TV’s features, see Chapters 5  
and 6.
- 14 For help, refer to the Troubleshooting Guide  
(☞ Chapter 7).
- 15 For lamp unit replacement instructions, see Chapter 8.
- 16 For technical specifications and warranty information, see  
Chapter 8.
- 17 Enjoy your new TV!

## Chapter 1: Introduction

# TV front and side panel controls and connections

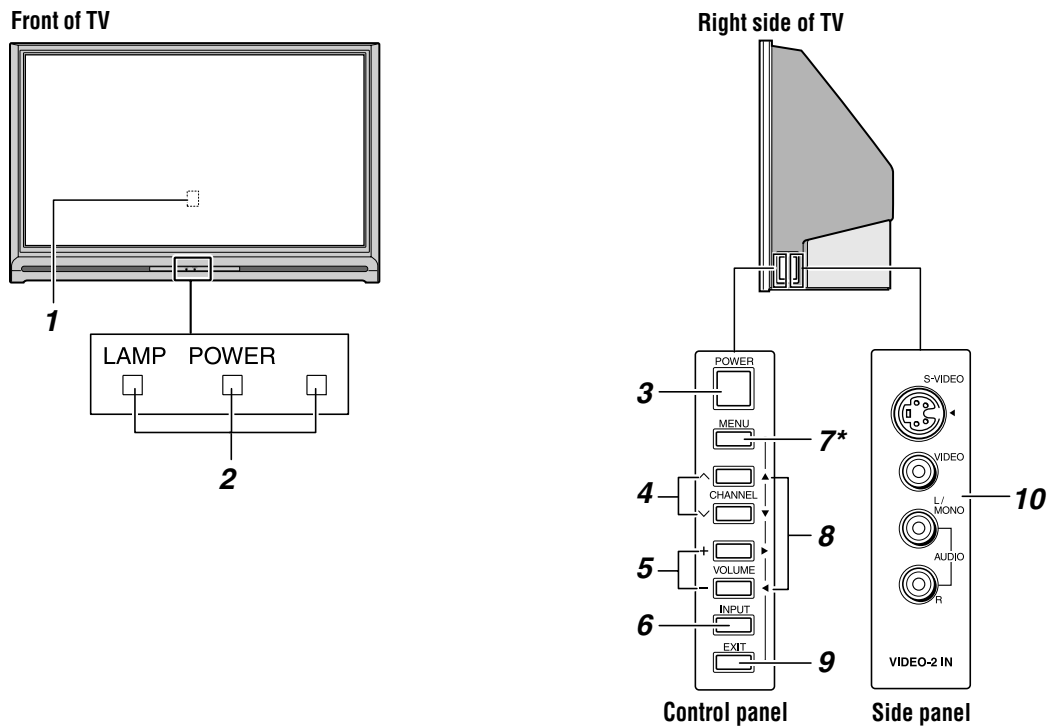

- 1 Remote sensor** (behind the screen) — Point the remote control toward this area of the TV screen. See “Remote control effective range” (page 7).
- 2 Blue, Yellow and Green/Red LEDs**  
See “LED indications” (page 46) for additional information.
- 3 POWER** — Press to turn the TV on and off.  
If the TV stops responding to the controls on the remote control or TV control panel and you cannot turn off the TV, press and hold the **POWER** button on the TV control panel for 5 or more seconds to reset the TV.
- 4 CHANNEL**  $\wedge \vee$  — When no menu is on-screen, these buttons change the channel (programmed channels only; page 17). When a menu is on-screen, these buttons function as up/down menu navigation buttons.
- 5 VOLUME**  $+ -$  — When no menu is on-screen, these buttons adjust the volume level. When a menu is on-screen, these buttons function as left/right menu navigation buttons.
- 6 INPUT** — Repeatedly press to change the source you are viewing (**ANT 1, VIDEO 1, VIDEO 2, ColorStream HD-1, ColorStream HD-2, HDMI 1, HDMI 2, ANT 2**).
- 7 \*MENU (ENTER)** — Press to access the menu system (pages 14–15). When a menu is on-screen, the **MENU** button on the TV’s side control panel functions as the Enter button.
- 8 ARROWS**  $\blacktriangle \blacktriangledown \blacktriangleleft \blacktriangleright$  — When a menu is on-screen, these buttons function as up/down/left/right menu navigation buttons.
- 9 EXIT** — Press to instantly close an on-screen menu.
- 10 VIDEO-2 IN** — The side panel A/V connections are referred to as “**VIDEO 2**” and include standard A/V connections plus optional S-video.

## Chapter 1: Introduction

# TV back panel connections

For an explanation of cable types and connections, see the *Installation Guide*.

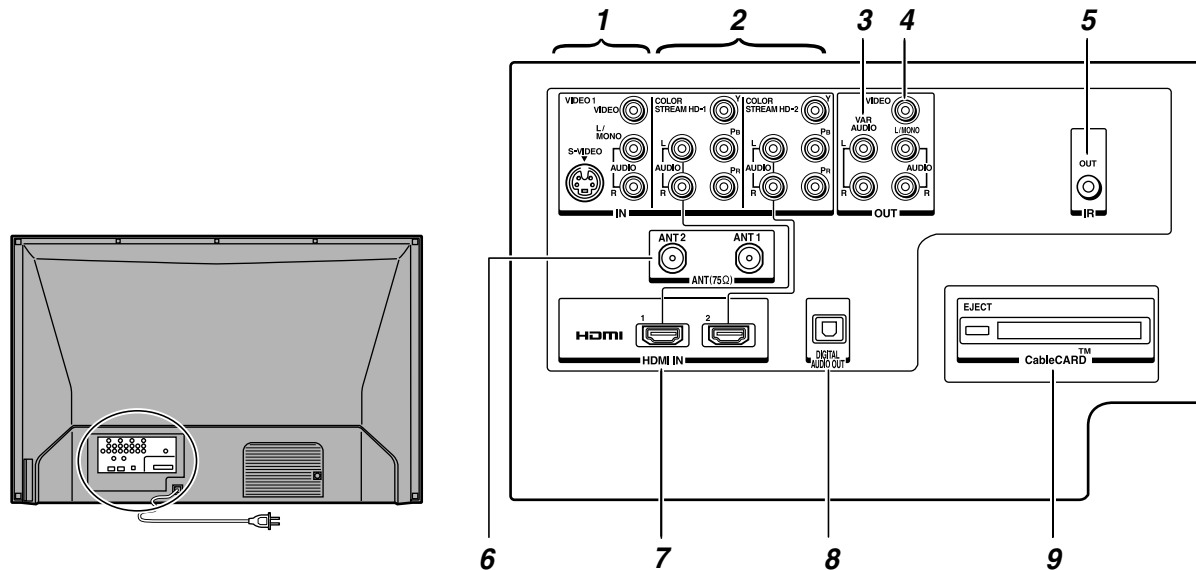

- 1 VIDEO 1 IN** — Standard (composite) video and standard audio inputs plus optional S-video inputs for connecting devices with composite video or S-video output.

*Note:* Standard (composite) video and S-video cables carry only video information; separate audio cables are required for a complete connection.

- 2 ColorStream® HD-1 and ColorStream® HD-2** — Two sets of ColorStream® high-definition component video inputs (with standard stereo audio inputs) for connecting devices with component video output, such as a Toshiba DVD player with ColorStream®.

*Note:* Component video cables carry only video information; separate audio cables are required for a complete connection.

**ColorStream® HD-1 and ColorStream® HD-2 Audio IN** — ColorStream HD-1/2 audio input terminals are shared with HDMI 1/2 analog audio input terminals, and their use can be configured in the **Setup** menu (ⓘ “Setting the ColorStream HD audio mode” page 20).

- 3 Variable Audio OUT** — Standard analog audio outputs for connecting an analog amplifier with external speakers.

- 4 A/V OUT** — Standard composite video and analog audio outputs for connecting a VCR for editing and dubbing.

- 5 IR OUT** — For controlling infrared remote-controlled devices through the TV. You can connect up to two devices with an IR blaster cable, and then control the devices using the TV’s IR pass-through features.

- 6 ANT 1 and ANT 2** — Two inputs that support analog (NTSC) and digital (ATSC) off-air antenna signals and analog and digital (QAM) Cable TV signals.

*Note:* If you have an antenna only, connect it to **ANT 1**. If you have both cable TV and an antenna, connect the cable TV to **ANT 1** and the antenna to **ANT 2**.

- 7 HDMI™ 1 and 2 IN** — Two High-Definition Multimedia Interface inputs receive digital audio and uncompressed digital video from an HDMI device or uncompressed digital video from a DVI device. Also see item 2.

- 8 Digital Audio OUT** — Optical audio output in Dolby Digital or PCM (pulse-code modulation) format for connecting an external Dolby Digital decoder, amplifier, A/V receiver, or home theater system with optical audio input.

- 9 CableCARD™ slot** — For use with a digital security card and digital cable TV service (provided by your local cable operator) to view encrypted digital programming (ⓘ page 20).

HDMI, the HDMI logo and High-Definition Multimedia Interface are trademarks or registered trademarks of HDMI Licensing LLC. CableCARD is a trademark of Cable Television Laboratories, Inc.

## Chapter 2: Using the remote control

### Preparing the remote control for use

Your TV remote control can operate your TV and many other devices such as cable converter boxes, satellite receivers, VCRs, DVD players, and HTIBs (home theater in a box), even if they are different brands.

#### If you have a Toshiba device:

Your TV remote control is preprogrammed to operate most Toshiba devices (☞ page 11).

#### If you have a non-Toshiba device or a Toshiba device that the remote control is not preprogrammed to operate:

You can program the TV remote control so it will operate the other device (☞ pages 9–13).

### Installing the remote control batteries

- 1 Remove the battery cover from the back of the remote control.

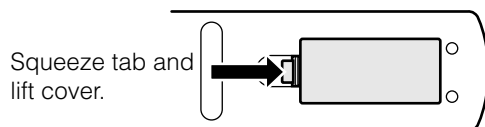

- 2 Install two “AAA” size batteries, making sure to match the + and – signs on the batteries to the signs on the battery compartment.

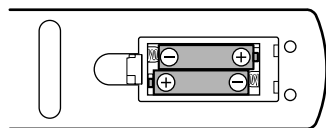

- 3 Reinsert the battery cover in the remote control until the tab snaps.

**Caution:** Never throw batteries into a fire.

#### Notes:

- Be sure to use AAA size batteries.
- Dispose of batteries in a designated disposal area.
- Batteries should always be disposed of with the environment in mind. Always dispose of batteries in accordance with applicable laws and regulations.
- If the remote control does not operate correctly, or if the operating range becomes reduced, replace batteries with new ones.
- When necessary to replace batteries in the remote control, always replace both batteries with new ones. Never mix battery types or use new and used batteries in combination.

- Always remove batteries from remote control if they are dead or if the remote control is not to be used for an extended period of time. This will prevent battery acid from leaking into the battery compartment.

### Remote control effective range

For optimum performance, aim the remote control directly at the TV and make sure there is no obstruction between the remote control and the TV.

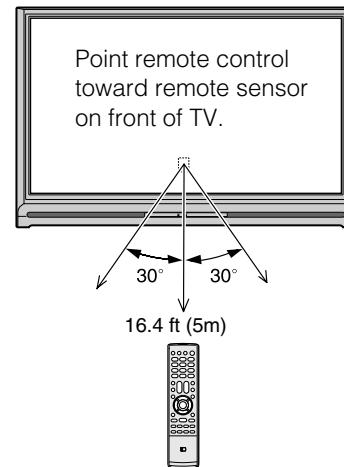



## Chapter 2: Using the remote control

### Learning about the remote control

The buttons used for operating the TV only are described here. For a complete list of the remote control's functions, see the remote control functional key chart (page 10).

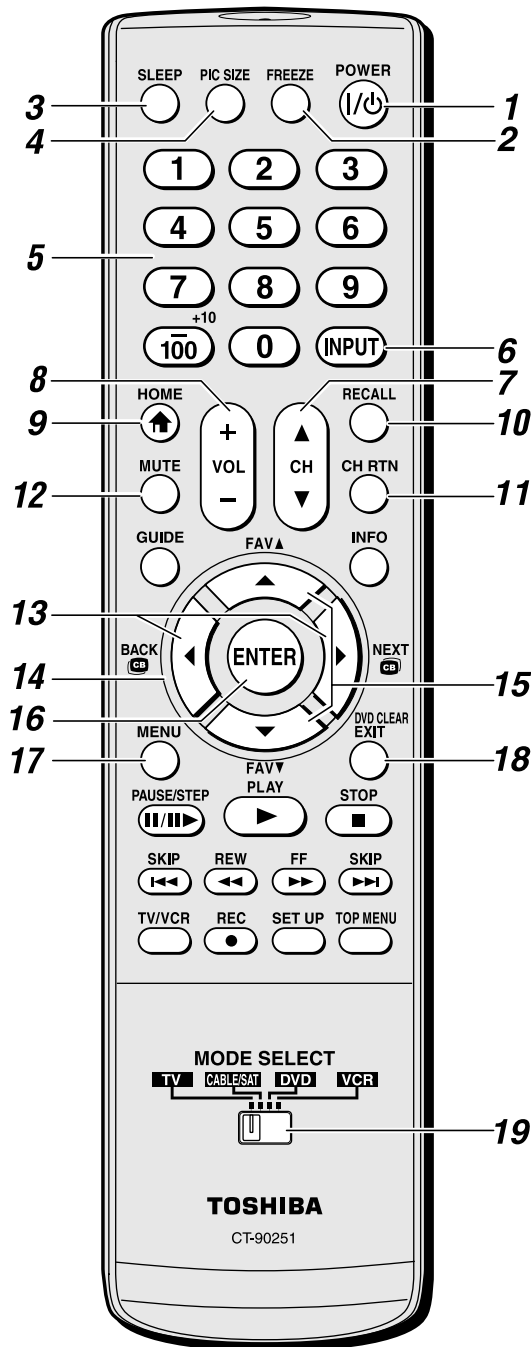

**Note:** The error message "NOT AVAILABLE" may appear if you press a key for a function that is not available.

**1 POWER** turns the TV on and off. Press **POWER** to turn on the TV. The blue LED indicator on the TV front will be illuminated. Press **POWER** again to turn off the TV.

**Note:** The Quick Restart™ setting will affect the amount of time it takes for the picture to appear when you turn on the TV (page 20).

**2 FREEZE** freezes the picture. Press again to restore the moving picture.

**3 SLEEP** accesses the sleep timer (page 39).

**4 PIC SIZE** cycles through the five picture sizes: **Natural**, **TheaterWide 1/2/3**, and **Full** (page 27).

**5 Channel Numbers (0-9, -/100)** directly tune channels. The "-" button is used to tune digital channels (page 26) or to display the favorite channel list (page 19).

**6 INPUT** selects the video input source (page 23).

**7 CH ▲▼** cycles through programmed channels when no menu is on-screen (page 17) and functions as page up/down when a menu is on-screen.

**8 VOL + -** adjusts the volume level.

**9 HOME** (house icon) accesses the home function of the Channel Browser™ feature (page 26).

**10 RECALL** displays TV setting information on-screen (page 40).

**11 CH RTN** returns to the last viewed channel (page 26).

**12 MUTE** reduces or turns off the sound (page 32).

**13** **BACK** / **ENTER** / **FAV** / **NEXT** While watching TV, these buttons open the Channel Browser™ banner and tune to the previous/next channel in the channel history (page 24). (Also see "Arrow buttons".)

**14 Arrow buttons (▲▼◀▶)** When a menu is on-screen, these buttons select or adjust programming menus. (Also see **BACK** / **ENTER** / **FAV** / **NEXT**.)

**15 FAV ▲▼** tunes to the next higher/lower favorite channel (page 19).

**16 ENTER** activates highlighted items in the main menu system.

**17 MENU** accesses the main TV menu system (pages 14 and 15).

**18 EXIT** closes on-screen menus.

**19 MODE SELECT Switch** switches between TV, CABLE/SAT, DVD, and VCR modes (page 9). Set to "TV" to control the TV.



## Chapter 2: Using the remote control

### Using the remote control to control your other devices

If you have a non-Toshiba device or a Toshiba device that the remote control is not preprogrammed to operate, you must first program the remote control to recognize the device (if you have not already done so) (see pages 11–13).

#### To use your TV remote control to operate a:

- Cable converter box or satellite receiver, set the MODE SELECT Switch to **CABLE/SAT**.
- VCR, set the MODE SELECT Switch to **VCR**.
- DVD player or HTIB, set the MODE SELECT Switch to **DVD**.

**Note:** Even after the TV remote control is programmed, it may not operate certain features on your other device. If this happens and you wish to use those features, you will need to use the device's original remote control.

Point the remote control directly at the device.

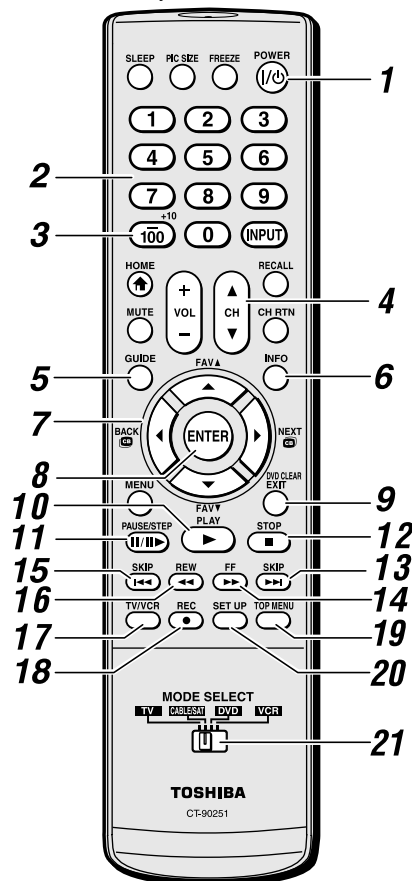

- 1 POWER** Turns the selected device on and off.
- 2 Channel Numbers (0-9)** Press to directly access channels (as opposed to  $\text{CH}$   $\text{▲▼}$ ).
- 3 +10** Press to directly access DVD chapters higher than 10.
- 4 CH ▲▼**
  - ▲ selects the next higher channel;
  - ▼ selects the next lower channel (for channels programmed into memory only).
- 5 GUIDE** Displays channel guide.
- 6 INFO** Displays TV status information on-screen.
- 7 ▲▼◀▶** Press to navigate DVD menus (may not work on some DVD players).
- 8 ENTER** Required by some satellite receivers and DVD players.
- 9 DVD CLEAR** Press to reset the title and chapter number.
- 10 PLAY** Begins playback of a tape or DVD.
- 11 PAUSE** Press during play or record mode to pause the picture; press again to restart.
- 12 STOP** Stops the tape or DVD.
- 13 SKIP ►►** Skips forward to locate later DVD chapters.
- 14 FF** Fast-forwards the tape or DVD. (Press during play mode to view the picture moving rapidly forward.)
- 15 SKIP ◀◀** Skips back to beginning of current DVD chapter or locates previous chapters.
- 16 REW** Rewinds/reverses the tape or DVD. (Press during play mode to view the picture moving rapidly backward.)
- 17 TV/VCR** To view one program while recording another, press to select TV mode.
- 18 REC** Starts tape recording.
- 19 TOP MENU** Accesses a DVD's top menu.
- 20 SET UP** Accesses a DVD's setup menu.
- 21 MODE SELECT Switch** Set to "TV" to control the TV; "CABLE/SAT" to control a cable converter box or satellite receiver; "DVD" to control a DVD player or HTIB; "VCR" to control a VCR.

## Chapter 2: Using the remote control

### Remote Control functional key chart

**Notes:**

- “---” = key does not send a signal in that remote control mode.
- ←TV = key will affect the TV, even when the remote control is not in the “TV” device mode.

REMOTE CONTROL KEY	Toshiba TV (TV)	CABLE	SAT (satellite)	VCR	DVD
POWER	Power	Power	Power	Power	Power
SLEEP	Sleep timer	← TV	← TV	← TV	← TV
INPUT	TV/Video select	← TV	← TV	← TV	← TV
1-9	Digit 1-9	Digit 1-9	Digit 1-9	Digit 1-9	Digit 1-9
0	Digit 0	Digit 0	Digit 0	Digit 0	Digit 0
100/-/+10	– (sub channel)	---	– (sub CH)	100	+10
RECALL	RECALL	← TV	← TV	Display	← TV
CH RTN	Previous channel	---	---	---	---
INFO	---	---	Info	---	---
MENU	Menu/DVD Menu	---	Menu	---	DVD Menu
▲▼/FAV▲▼	Menu select/ FAV up/down	---	Menu up/down	---	Menu up/down
BACK CB	Menu select/ Channel Browser™	---	Menu left	---	Menu left
NEXT CB	Menu select/ Channel Browser™	---	Menu right	---	Menu right
ENTER	Enter	---	Select Enter	---	Enter
EXIT/DVD CLEAR	Exit	---	Exit	---	DVD Clear
VOL + –	Volume up/down	← TV	← TV	← TV	← TV
CH▲▼	Channel up/down	Channel up/down	Channel up/down	Channel up/down	---
PIC SIZE	Picture size	← TV	← TV	← TV	← TV
MUTE	Sound mute	← TV	← TV	← TV	← TV
GUIDE	---	---	SAT Guide	---	---
FF	---	---	---	Fast FWD	Fast FWD
PAUSE/STEP	---	---	---	Pause	Pause
PLAY	---	---	---	Play	Play
REW	---	---	---	Rewind	Rewind
HOME	Channel Browser™ Home	---	---	---	---
STOP	---	---	---	Stop	Stop
FREEZE	Freeze picture	← TV	← TV	← TV	← TV
SKIP ◀◀	---	---	---	---	Skip REV
SKIP ▶▶	---	---	---	---	Skip FWD
TV/VCR	---	---	---	TV/VCR	---
REC	---	---	---	Record (2 click)	---
SET UP	---	---	---	---	DVD Setup
TOP MENU	---	---	---	---	Top Menu

## Chapter 2: Using the remote control

### Programming the remote control to control your other devices

Your Toshiba TV remote control is preprogrammed to operate most Toshiba devices. To program your TV remote control to operate a non-Toshiba device (or a Toshiba device that it is not preprogrammed to operate), follow the steps below. For details on using the remote control to operate the device, see page 9.

- 1** In the remote control code table (page 12), find the code for your device. If more than one code is listed, try each one separately until you find one that works.
- 2** Set the MODE SELECT Switch to the type of device you are programming the remote control to operate — CABLE/SAT (for a cable converter box or satellite receiver), DVD (for a DVD player or HTIB [home theater in a box]), or VCR (for a VCR or TV/VCR combo).
- 3** While holding down **RECALL**, press the Channel Number buttons to enter the 3-digit code for your device.
- 4** To test the code, turn on the device, point the remote control at it, and press **POWER**. See notes below.
  - If the correct code was entered, the device will turn off.
  - If the device does not respond, repeat steps 1–4 using another code.
  - If the device does not respond to another code, you will need to use the remote control that came with the device.
- 5** Remember to set the MODE SELECT Switch back to TV to control the TV.
- 6** For future reference, write down the code(s) you used:

DEVICE	CODE	DEVICE	CODE

#### Notes:

- In addition to **POWER**, confirm that all necessary keys on the TV remote control operate your device. If some keys are not operational, repeat the device code setup using another code (if other codes are listed for your device). If, after trying all listed codes, the necessary keys do not operate your device, use the device's original remote control.
- Every time you change the batteries, you will need to reprogram the remote control.
- Some newer VCRs respond to either of two codes. These VCRs have a switch labeled "VCR1/VCR2." If your VCR has this kind of switch and does not respond to the codes for your VCR brand, set the switch to the other position ("VCR1" or "VCR2") and reprogram the remote control.

## Chapter 2: Using the remote control

### Remote control codes

In some cases you may not be able to operate your device with the TV remote control. Your other device may use a code that is not recognized by the TV remote control. If this happens, use the device's remote control.

#### Cable converter box

ABC	061, 062, 063, 082, 084, 087, 091, 092, 096, 098
Archer	065, 092, 097, 099
Cableview	064, 094
Century	092
Citizen	090, 092, 097
Contec	083, 085, 086, 088, 093, 098
Diamond	093
Eagle	091
GE	061, 062
Gemini	069, 070, 094
General Instruments	062, 089, 096
Hamlin	093
Hitachi	062, 095, 096
Jasco	097
Jerrold	062, 069, 071, 082, 086, 089, 091, 096
Magnavox	072, 096
Memorex	091, 092, 104
Multi Canal	090
Novavision	101
Panasonic	081, 083, 085
Philco	087
Philips	066, 067, 068, 070, 072, 073, 074, 075, 091, 092
Pioneer	076, 077
Proscan	061, 062
Radio Shack	092, 097, 099
RCA	064, 081
Realistic	065
Recoton	102
Samsung	077, 090
Scientific Atlanta	063, 078, 079, 080, 088, 098, 101, 105
Sears	095
Signature	062
Signature 2000	096
Sprucer	081, 085
Starcom	069, 082, 087, 096, 103, 104
Stargate	069, 090
Sylvania	095, 100
TeleView	090
Texscan	100
Tocom	071, 084, 085
U. S. Electronics	087, 096, 098
United Cable	082
Universal	065, 092, 097, 099, 102, 103
Wards	096

#### Satellite receiver

Alphastar	038, 059
Chaparral	034
DISH Network	057

Drake	020, 040, 044, 046, 050, 053
Echostar	018, 041, 051
Express Vu	057
Fujitsu	027
GE	008, 009, 013
General Instruments	010, 011, 012, 022, 023, 031, 049
Hitachi	033
Hughes	033
Hughes Network Systems	019
Intersat	048
Janeil	027
JVC	017, 057
Kenwood	029
Magnavox	060
Optimus	058
Pansat	036, 052
Primestar	015, 042
Proscan	008, 009, 013
Radio Shack	022, 023, 030
RCA	008, 009, 013, 016
Realistic	030
Samsung	059
Sony	014, 055
Star Choice	057
Star Trak	025, 026, 037, 054
STS	024
Toshiba	000, 001, 002, 003, 004, 005, 006, 007, 020, 031, 056
Uniden	021, 028, 030, 032, 035, 039, 043, 045, 047, 058
Zenith	027

#### TV/VCR Combo

Action	078
GE	059, 062
Goldstar	065
Panasonic	065
Precision	078
Quasar	065
Realistic	079
Sony	074
Toshiba	057
Totevision	009, 010, 065
Zenith	065

#### DVD/VCR Combo

Go Video	DVD=087, VCR=081
JVC	DVD=088, VCR=082
RCA	DVD=089, VCR=083
Samsung	DVD=090, VCR=084
Sanyo	DVD=091, VCR=085
Zenith	DVD=092, VCR=086

#### DVD player

Aiwa	006, 015
Apex	016, 017
BOSE	097
Broksonic	018
Clarion	019

Classic	020
Daewoo	021
Denon	022, 023, 024, 025
Emerson	026, 027
Fisher	028
Funai	027
GE	001, 029, 030
Go Video	087
GPX	031
Hitachi	005, 032, 033, 034, 035
JVC	003, 007, 036, 042, 088
Kenwood	037
Konka	008, 009
Magnavox	004, 038
Memorex	039
Mintek	040
NAD	026
Nakamichi	041
Norcent	043
Onkyo	044
Oritron	058
Panasonic	010, 045, 046, 047, 048, 049, 050
Philips	004, 051
Pioneer	052, 053, 054, 055
Proscan	001, 056
Qwestar	057, 058
RCA	001, 002, 059, 089
Sampo	060
Samsung	061, 062, 086, 090
Sansui	073
Sanyo	063, 091
Sharp	064, 067
Sherwood	074
Sony	011, 012, 065, 066, 068, 069, 070
Sylvania	027
Teac	071
Technics	072
Techwood	075
Toshiba	000, 013, 076, 077, 078
Yamaha	079, 080, 081
Zenith	014, 082, 092

#### Portable DVD player

Aiwa	093
Audiovox	094, 095
Panasonic	024, 096, 099
RCA	098

#### VCR

Admiral	049
Aiko	019
Aiwa	018
Akai	003, 004, 037, 038, 039, 058, 069
Audiovox	010
Bell & Howell	007, 068
Broksonic	008, 017
Calix	010
Carver	026
CCE	019
Citizen	009, 010, 011, 012, 013, 014, 015, 019, 057, 073
Colortyme	005
Craig	009, 010, 016, 061, 065, 079







**Chapter 2: Using the remote control**

Curtis Mathes	001, 005, 009, 012, 014, 040, 048, 053, 056, 057	Panasonic	036, 045, 046, 057, 061, 072, 079	Wards	009, 010, 011, 016, 018, 020, 024, 025, 031, 035, 049, 051, 056, 057, 060, 065, 066, 079
Daewoo	011, 013, 015, 017, 018, 019, 057, 078	Pentax	012, 024, 025, 035, 042, 053, 063	White Westinghouse	073
Daytron	078	Pentex Research	014	XR-1000	018
Denon	063	Philco	026, 027, 063	Yamaha	005, 006, 007, 014, 037, 053
Dimensia	001, 048	Philips	026, 031, 044, 057	Zenith	004, 032, 034, 041, 047, 069, 086
Electrohome	010, 020, 065	Pioneer	006, 024, 043, 055	<b>HTIB</b>	
Emerson	003, 008, 010, 011, 017, 018, 020, 028, 039, 054, 057, 062, 065, 068, 072	Portland	012, 013, 015	Lasonic	083
Fisher	007, 016, 021, 022, 023, 057, 064, 068, 070, 071, 079	Proscan	001, 002, 048	Panasonic	084
Fuji	004, 041	Proton	061	Venturer	085
Funai	018, 073	Quasar	045		
Garrard	018	Radio Shack	010, 031, 065		
GE	001, 002, 009, 040, 042, 048, 056	Radio Shack/Realistic	007, 009, 010, 016, 018, 020, 021, 022, 031, 049		
Go Video	056, 059, 061, 081	Radix	010		
Goldstar	005, 010, 014, 054, 056, 065, 067	RCA	001, 002, 003, 009, 024, 025, 029, 035, 040, 042, 045, 048, 055, 056, 063, 071, 083		
Gradiente	018, 065	Realistic	007, 009, 010, 011, 016, 018, 020, 021, 022, 031, 049, 051, 056, 060, 065, 075, 079		
Harman Kardon	005	Ricoh	047		
Hitachi	024, 025, 035, 037, 042, 063, 070, 080	Runco	034		
JBL	076	Samsung	009, 011, 038, 056, 073, 084		
JC Penney	005, 006, 007, 008, 009, 010, 023, 024, 025, 026, 035, 056, 061, 063, 065	Sansui	006, 037, 043, 061		
Jensen	024, 025, 037	Sanyo	007, 009, 016, 054, 064, 068, 071, 075, 079, 085		
JVC	005, 006, 007, 014, 037, 043, 062, 063, 068, 082	Scott	008, 011, 017, 028, 030, 057, 065, 072		
Kenwood	005, 006, 007, 012, 014, 037, 043, 053, 068, 071	Sears	007, 010, 016, 021, 022, 023, 024, 025, 035, 053, 057, 063, 064, 065, 068, 071, 075, 079		
Kodak	010	Sharp	013, 020, 031, 049, 051, 060, 066		
LG	010	Shintom	004, 025, 032, 061		
Lloyds	053, 073, 079	Signature	049		
Logik	061	Signature 2000	075		
LXI	010	Singer	047, 061		
Magnasonic	061, 065, 078	Sony	004, 032, 033, 041, 052, 058, 070, 074, 076, 077, 080		
Magnavox	026, 027, 034, 044, 057, 061, 072	STS	035		
Marantz	005, 006, 007, 012, 014, 026, 053, 067	Sylvania	018, 026, 027, 028, 044, 072		
Memorex	007, 009, 010, 016, 018, 034, 049, 063, 065, 066, 068, 075, 079	Symphonic	018, 051, 053, 073, 079		
MGA	020, 028, 039	Tandy	007		
MGN	056	Tashiko	010		
Minolta	024, 025, 035, 063	Tatung	037		
Mitsubishi	020, 024, 025, 028, 039, 043, 065	Teac	018, 029, 037		
Montgomery Ward	049	Technics	036		
Motorola	049	Teknika	010, 018, 065		
MTC	009, 046, 061	Toshiba	000, 011, 021, 023, 024, 028, 030, 039, 057, 074, 078, 079		
Multitech	009, 012, 018	Totevision	009, 010, 065		
NEC	005, 006, 007, 012, 014, 037, 043, 053, 054, 067, 070	Unitec	073		
Nikko	010	Unitech	009		
Noblex	009	Vector Research	005, 006, 011, 012, 053		
Optimus	010, 049, 065	Video Concepts	005, 006, 011, 012, 039, 053		
Optonica	031				
Orion	054, 057, 062, 065, 068, 072				

## Chapter 3: Menu layout and navigation

### Main menu layout



The illustrations below and on the next page provide a quick overview of your TV's menu system. To open the main menus (illustrated below), press  on the remote control or TV control panel.

Icon	Item	Option
	Channel Browser	→ [Launches the Channel Browser™]
	Digital CC/Audio Selector	→ [Launches the ATSC Digital CC Selector] (This option is not available, if you are not on a digital channel).
	CableCARD™	→ Dynamic list of items provided by Cable company. (This option is not available if a CableCARD™ is not inserted.)
	Picture Settings	→ [Picture Settings edit window]
	Advanced Picture Settings	→ [Advanced Picture Settings edit window]
	Theater Settings	→ [Theater Settings edit window]
	Audio Settings	→ [Audio Settings window]
	Advanced Audio Settings	→ [Advanced Audio Settings window]
	Audio Setup	→ [Audio Setup window]
	Favorite Channels	→ [Favorite Channels edit window]
	Closed Caption Mode	→ Off/CC1/CC2/CC3/CC4/T1/T2/T3/T4
	Closed Caption Advanced	→ [Closed Caption Advanced window]
	Input Labeling	→ [Input Labeling edit window]
	Menu Language	→ English / Français / Español
	Channel Browser Setup	→ [Channel Browser Setup window]
	Enable Rating Blocking	→ Off/On
	Edit Rating Limits	→ [Edit Rating Limits edit window]
	Channels Block	→ [Channels Block edit window]
	Input Lock	→ Off/Video/Video+
	Front Panel Lock	→ Off/On
	New PIN Code	→ [New PIN Code entry window]
		Installation
Sleep Timer		→ [Sleep Timer edit window]
ColorStream HD1 Audio		→ No/Yes
HDMI 1 Audio		→ Auto / Digital / Analog
ColorStream HD2 Audio		→ No/Yes
HDMI 2 Audio		→ Auto / Digital / Analog
Quick Restart		→ Off/On

## Chapter 3: Menu layout and navigation

### Setup/Installation menu layout

To open the **Installation** menu (illustrated below), press **MENU** on the remote control or TV control panel, open the **Setup** menu, select **Installation**, and press **ENTER**.

Icon	Item	Option
Press <b>MENU</b> . Open the <b>Setup</b> menu, and then open the <b>Installation</b> sub-menu. 	Input Configuration	→ [Input Configuration window]
	Channel Program	→ ANT1 → [Scans for new channels on desired Antenna] → ANT2 → [Scans for new channels on desired Antenna]
	Channel Add/Delete	→ [Channel Add / Delete Window]
	Signal Meter	→ [Signal Meter Window]
<b>System Status</b> 	System Information	→ [Opens the System Information window]

### Navigating the menu system

You can use the buttons on the remote control or TV control panel to access and navigate your TV's on-screen menu system.

- Press **MENU** to open the menu system.
- When a menu is open, use the up/down/left/right arrow buttons (▲▼◀▶) on the remote control or TV control panel to move in the corresponding direction in the menu.
- Press **ENTER** to save your menu settings or select a highlighted item. (A highlighted menu item appears in a different color in the menu.)
- All menus close automatically if you do not make a selection within 60 seconds, except the signal meter menu, which closes automatically after about 5 minutes.
- To close a menu instantly, press **EXIT**.

**Note:** The menu background may sometimes appear black, depending on the signal the TV is receiving. This is not a sign of malfunction.

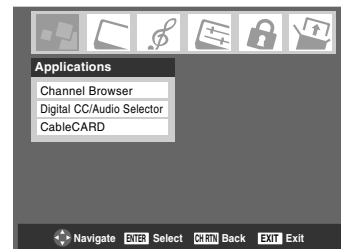



## Chapter 4: Setting up your TV

### Selecting the menu language

You can choose from three different languages (English, French and Spanish) for the on-screen display of menus and messages.

To select the menu language:

- 1 Press **MENU** and open the **Preferences** menu.
- 2 Highlight **Menu Language** and press **▶**.
- 3 Press **▲** or **▼** to select your preferred menu language and press **ENTER**.



- 4 Press **EXIT** to close the **Preferences** menu.

### Configuring the antenna input sources for the ANT 1 and ANT 2 terminals

To configure the ANT 1 and ANT 2 input sources:

- 1 Press **MENU** and open the **Setup** menu.
- 2 Highlight **Installation** and press **ENTER**. (A new set of **Installation** menu icons will appear on-screen, as shown in step 3 below.)

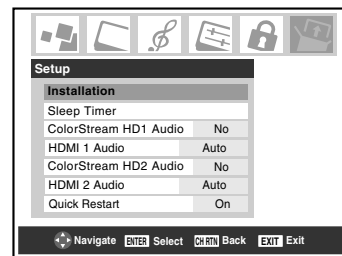

- 3 Open the **Terrestrial** menu, highlight **Input Configuration**, and press **ENTER**.

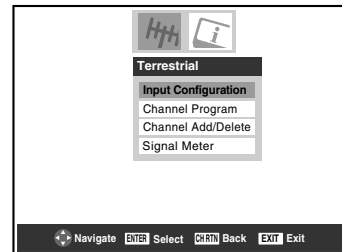

- 4 Press **▲** or **▼** to highlight **ANT 1**, and press **◀** or **▶** to select the input source (**Cable** or **Antenna**) for the **ANT 1** input on the TV.
- 5 Press **▼** to highlight **Antenna 2 in** and then **◀** or **▶** to select the input source (**Cable** or **Antenna**) for the **ANT 2** input on the TV, if applicable. If you have not connected anything to the **ANT 2** input, skip this step.

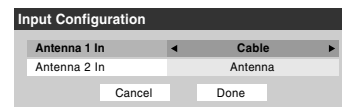

- 6 To save your new settings, highlight **Done** and press **ENTER**. To revert to your original settings, highlight **Cancel** and press **ENTER**.

## Chapter 4: Setting up your TV

### Programming channels into the TV's channel memory

When you press **CH** or **CH** on the remote control or TV control panel, your TV will stop only on the channels you program into the TV's channel memory.

Follow the steps below to program channels into the TV's channel memory.

#### Programming channels automatically

Your TV can automatically detect all active channels in your area and store them in its memory. After the channels are programmed automatically, you can manually add or erase individual channels.

##### Notes:

- You must configure the antenna input sources before programming channels (see page 16).
- If the input signal type is set to **Cable** for an antenna input, the automatic channel programming process erases channels that were previously programmed into the TV's memory.
- If the input signal type is set to **Antenna**, the automatic channel programming process does NOT erase channels that were previously programmed into the TV's memory, but adds newly found channels to the existing set of programmed channels. To remove a channel from the memory, you must manually delete it.
- To tune the TV to a channel not programmed in the channel memory, you must use the Channel Number buttons on the remote control.
- Programming channels for an antenna input configured for **Cable** will take substantially longer than for an antenna input configured for **Antenna**. This is normal; however, once channel programming is completed, you should not have to repeat the programming process again unless your Cable TV service lineup changes significantly.
- If you have a CableCARD™ inserted, channel programming for **ANT 1** is disabled because the CableCARD™ automatically loads the Cable channel list into the TV's channel memory. See Installation Guide for details on CableCARD™.

#### To program channels automatically:

- Make sure you have configured the antenna input sources (see page 16).
- Press **MENU** and open the **Setup** menu.

- Highlight **Installation** and press **ENTER**. (A new set of **Installation** menu icons will appear on-screen, as shown in step 4.)

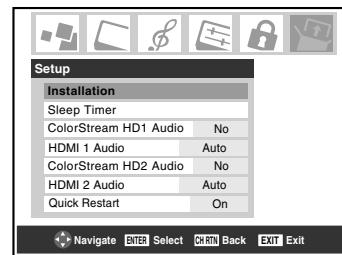

- Open the **Terrestrial** menu, highlight **Channel Program**, and press **ENTER**.

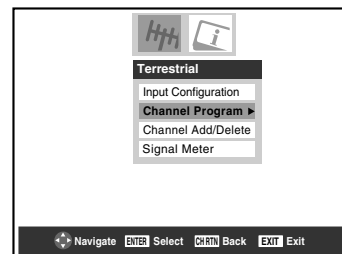

- Highlight **ANT 1** or **ANT 2**, depending on which antenna input you want to program channels for, and then press **ENTER** to start automatic channel programming.



The TV will automatically cycle through all the channels for the antenna input you selected, and store all active channels in the channel memory. While the TV is cycling through the channels, the message "Scanning channels, please wait" appears (as shown above).

- To cancel channel programming, either press **EXIT** or highlight **Abort** in the on-screen display and press **ENTER**. When channel programming is done, press **CH** or **CH** to view the programmed channels.

### Manually adding and deleting channels in the channel memory

After automatically programming channels into the channel memory, you can manually add or delete individual channels.

#### To add or delete channels in the channel memory:

- Press **MENU** and open the **Setup** menu.
- Highlight **Installation** and press **ENTER**. (A new set of **Installation** menu icons will appear on-screen, as shown in step 3.)

(continued)

## Chapter 4: Setting up your TV

- 3** Open the **Terrestrial** menu, highlight **Channel Add/Delete**, and then press **ENTER**.

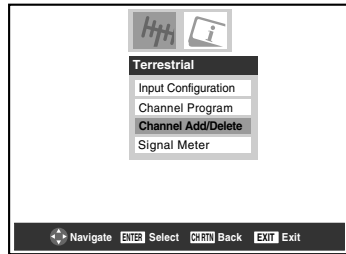

- 4** The illustration below left shows channels programmed for the ANT 1 antenna input. To view the list of channels programmed for the ANT 2 antenna input, press **▲▼** to highlight **ANT 2** and press **ENTER**.

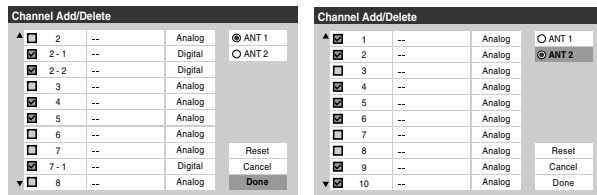

### To add a channel to the channel memory:

Highlight the unchecked box next to the channel number you want to add, and then press **ENTER** to check the box.

### To manually add digital subchannels on a physical channel:

Use the Channel Numbers and the Dash (**100**) on the remote control to enter the channel number (for example, 56-1). If the channel is found, the number will be added to the list and the box will be checked.

If the channel is not found, a message will appear.

### To remove a channel from the channel memory:

Highlight the checked box next to the channel number you want to remove, and then press **ENTER** to uncheck the box.

### To save your new settings:

Highlight **Done** and press **ENTER**.

### To revert to your original settings:

Highlight **Cancel** and press **ENTER** before saving.

### To remove all channels from the channel memory:

Highlight **Reset** and press **ENTER**, and then highlight **Done** and press **ENTER**.

#### Notes:

- This action applies to the current antenna input only. To delete/add channels on the other input, highlight the input you want (**ANT 1**, or **ANT 2**) and press **ENTER**.
- This action cannot be cancelled unless you highlight **Cancel** and press **ENTER** before saving your changes.

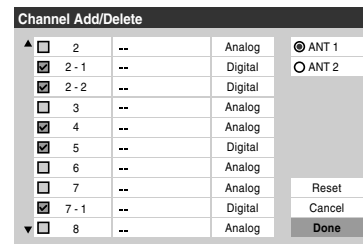

## Programming your favorite channels

You can program up to 18 channels as favorite channels into two Favorite Channel lists (nine channels from the **ANT 1** input, and nine from the **ANT 2** input). You can then scan through your favorite channels only, skipping other channels you do not normally watch.

### To add and delete channels in the Favorite Channels lists:

- Press **MENU** and open the **Preferences** menu.
- Highlight **Favorite Channels** and press **ENTER**.
- Use **▲▼** to select either **ANT 1**, or **ANT 2**, and press **ENTER**.
- Highlight **Edit** and press **ENTER**.

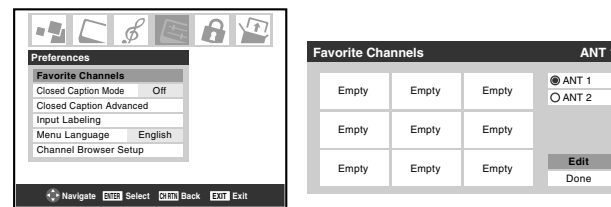

### To add a channel to the selected Favorite Channel list:

Use **▲▼** to highlight an unchecked box next to a channel you want to set as a favorite, and then press **ENTER** to check the box.

**Note:** You must first use *Channel Program* or *Channel Add/Delete* to add channels to the channel memory before setting up favorite channels.

## Chapter 4: Setting up your TV

### To delete the channel from the selected Favorite Channel list:

Highlight a checked box and press **ENTER** to uncheck it.

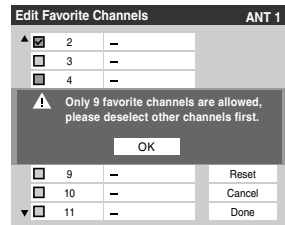

**Note:** If you try to add more than nine favorite channels per input, an error message will appear. You will need to delete (uncheck) a channel before you can add another.

When done, highlight **Done** and press **ENTER**.

### To program favorite channels for another input:

- Either... Highlight **ANT 1**, or **ANT 2**, which will change the favorite channel settings in the selected input. (This will not change the TV's current input.)
- Or... Press **INPUT** to select **ANT 1**, or **ANT 2** and then repeat steps 1–4, on page 18.

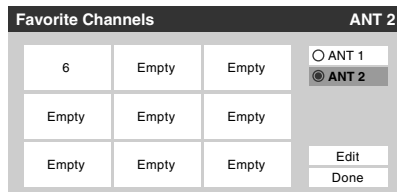

### To clear your favorite channel lists:

- 1 Press **MENU** and open the **Preferences** menu.
- 2 Highlight **Favorite Channels** and press **ENTER**.
- 3 Highlight **Edit** and press **ENTER**.
- 4 Highlight **Reset** and press **ENTER**.
- 5 Highlight **Done** and press **ENTER**.

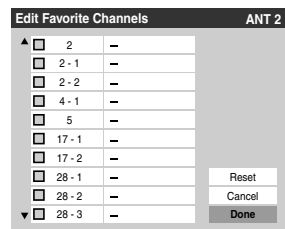

### To tune your favorite channels for the current ANT input:

Press **FAV▲** / **FAV▼**.

### To tune your favorite channels using the favorite channel list:

- 1 Press **100** to display the favorite channel list.
- 2 Press the corresponding number button (1-9) to select your desired channel.



**Note:** To tune your favorite channels for another input, press **INPUT** to select the other input.

## Chapter 4: Setting up your TV

### Setting the ColorStream HD audio mode

To set the ColorStream HD audio mode:

- 1 Press **MENU** and open the **Setup** menu.
- 2 Highlight **ColorStream HD1 (or 2) Audio** and press **▶**.
- 3 Press **▲** or **▼** to select **Yes** or **No** and press **ENTER** to display the information.

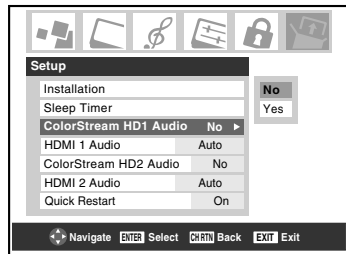

**Note:** The analog audio terminals for the ColorStream HD and HDMI inputs are used in common. When the ColorStream HD 1 (or 2) audio mode is set to **Yes**, the HDMI 1 (or 2) audio mode is set to **Digital** and will be greyed out. When the ColorStream HD 1 (or 2) audio mode is set to **No**, the HDMI 1 (or 2) Audio changes to **Auto**.

### Setting the HDMI™ audio mode

To set the HDMI audio mode:

- 1 Press **MENU** and open the **Setup** menu.
- 2 Highlight **HDMI 1 (or 2) Audio** and press **▶**.
- 3 Press **▼** or **▲** to select the HDMI audio mode (**Auto**, **Digital**, or **Analog**) and press **ENTER**. (**Auto** is the recommended mode.) See “Connecting an HDMI or DVI device to the HDMI input” (see *Installation Guide*).

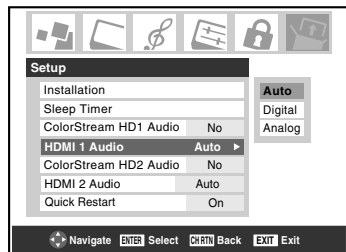

**Note:** The ColorStream HD1/HD2 Audio settings influence the HDMI Audio settings. If ColorStream HD1 (or 2) Audio is set to **No**, the HDMI 1 (or 2) Audio setting changes to **Auto**. If either ColorStream HD1 (or 2) Audio is set to **Yes**, the HDMI 1 (or 2) Audio setting is set to **Digital** and will be greyed out.

### Viewing the CableCARD™ menu

A CableCARD™ enables you to view encrypted digital channels. See “Connecting a digital CableCARD™” (see *Installation Guide*) for connection and subscription information.

**Note:** Connecting your TV directly to the Audio/Video output of your Set-Top-Box will assure a more vivid picture and enhance your viewing enjoyment.

After the CableCARD™ is inserted, a CableCARD™ option appears in the **Applications** menu, with informational screens provided by your digital CableCARD™ service (see illustrations below).

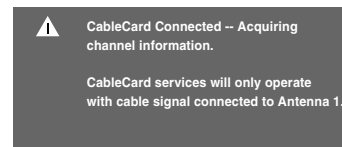

To view the CableCARD™ menu:

- 1 Press **MENU** and open the **Applications** menu.
- 2 Highlight **CableCARD™** and press **▶**.
- 3 Press **▲** or **▼** to select one of the side menu items and press **ENTER** to display the information.

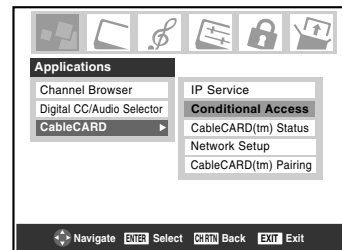

**Note:** The CableCARD™ menu is for informational purposes only and has no user-adjustable options.

### Setting the Quick Restart™ feature

With the Quick Restart™ feature set to **On**, the TV will stay in Standby mode for several minutes after the TV is turned off (see Note on page 21).

If the TV is turned on from Standby mode, the full picture appears immediately.

## Chapter 4: Setting up your TV

### To set the Quick Restart™ feature:

- 1 Press **MENU** and open the **Setup** menu.
- 2 Highlight **Quick Restart** and press **▶**.
- 3 Press **▼** or **▲** to select either **On** or **Off** and Press **ENTER**.

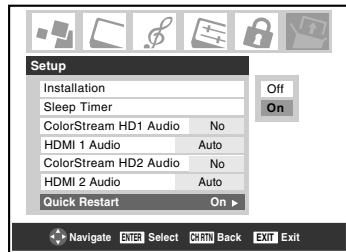

**Note:** If **Quick Restart** is set to **Off** and you turn off the TV, it can take several seconds for the picture to appear when you turn on the TV again. See "important notice about hot lamp restart," below.

If **Quick Restart** is set to **On** and you turn off the TV, the following will occur for a few minutes:

- The screen (lamp) lights dimly; and
- The fans continue to run.

This is a function of the Quick Restart Shutdown mode and is not a TV malfunction. If you do not prefer this, set the **Quick Restart** feature to **Off**.

When the **Quick Restart** feature is set to **Off**, if you repeatedly turn the TV on and off in a short period of time, the useful service life of the lamp may be shorter than the average useful service life (see page 47).

### IMPORTANT NOTICE ABOUT "HOT LAMP RESTART"

When the TV has been powered on long enough for the lamp unit to get hot, it may take several minutes for the picture to appear on-screen in the following situations:

- When the Quick Restart™ feature is set to **Off** and you turn the TV off and then on again within a few minutes; or
- If the TV is on when a short-term power failure, power surge, or other similar power failure occurs, such that the TV loses and regains power within a few minutes.

**This is a property of DLP™ TV lamp technology and is NOT a sign of malfunction.**

If this occurs, the yellow LED on the TV front panel will blink (and the blue LED will be lit solid) until the TV is finished restarting the lamp and the normal picture appears. If both LEDs are blinking, you will need to turn the TV off and then on again to restart the lamp.

## Viewing the digital signal meter

You can view the digital signal meter in the ANT 1 and ANT 2 digital TV input sources only.

### To view the digital signal meter:

- 1 Press **MENU** and open the **Setup** menu.
- 2 Highlight **Installation** and press **ENTER**.
- 3 A new set of Installation menu icons will appear on-screen, as shown below. Open the **Terrestrial** menu, highlight **Signal Meter**, and press **ENTER**.

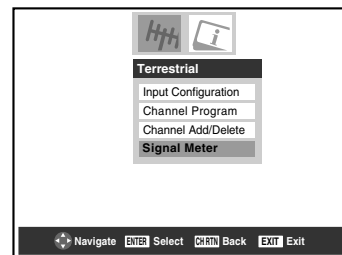

- 4 Press **▲▼◀▶** to select the antenna input and digital channel whose signal you want to check.

**Note:** The physical digital channel number listed in the Signal Meter screen may not correspond to a virtual TV channel number. Contact your local broadcasters to obtain the RF channel numbers for your local digital stations.

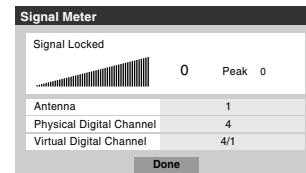

### To close the screen and return to the Terrestrial menu:

Highlight **Done** and press **ENTER**.

### To return to normal viewing:

Press **EXIT**.

## Chapter 4: Setting up your TV

### Viewing the system status

To view the system status:

- 1 Press **MENU** and open the **Setup** menu.
- 2 Highlight **Installation** and press **ENTER**. A new set of Installation menu icons will appear on-screen, as shown below right.

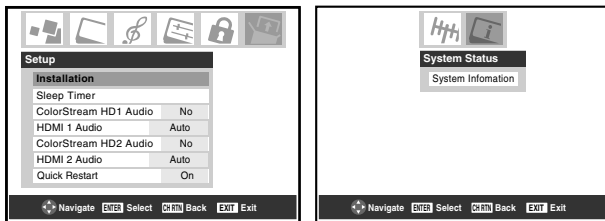

- 3 Open the **System Status** menu, highlight **System Information**, and press **ENTER**.
- 4 Press **◀▶** to scroll through the menu bar to check the **Product Information** and **Software Version**.

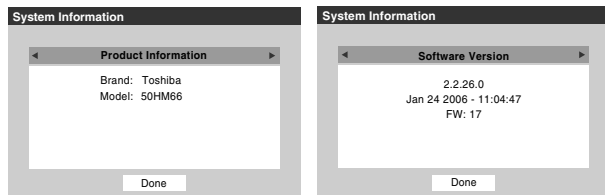

To close the screen and return to the Installation menu:

Highlight **Done** and press **ENTER**.

To return to normal viewing:

Press **EXIT**.

### Restore Factory Defaults

To restore all settings and channels to their factory default values:

- 1 Follow steps 1–3 above.
- 2 Press **◀▶** to scroll through the menu bar to select **Factory Defaults**.
- 3 Enter your PIN code (or 0000 if no PIN code has been set).
- 4 Highlight **Yes** and press **ENTER**. The TV will turn off automatically after a few seconds. After the TV turns off, unplug the TV power cord and then plug it in again to complete the restore process.

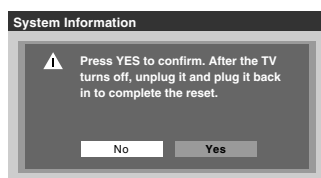

To cancel the reset:

Highlight **No** and press **ENTER**.

**Note:** If you have previously set the TV to **High Bright** mode, and have restored Factory Defaults, the TV will default to **Low Power** mode. To set the TV back to **High Bright** mode, see page 42.



## Chapter 5: Using the TV's basic features

### Selecting the video input source to view

To select the video input source to view:

- 1 Press **INPUT** on the remote control or **INPUT** on the TV control panel.
- 2 Press 0–7 to select the input source you want to view, which will depend on the input terminals you used to connect your devices (see *Installation Guide*).  
The current signal source displays in the top right corner of the **Input Selection** screen.

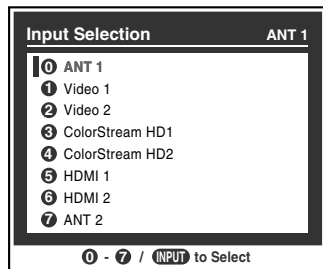

#### Notes:

- When the **Input Selection** screen is open, you also can use **▲▼** on the remote control (or the **CHANNEL ▲▼** buttons on the control panel) to change the input.
- You can repeatedly press **INPUT** on the remote control or the **INPUT** button on the TV control panel to change the input.
- You can label the video input sources according to the specific devices you have connected to the TV (see "Labeling the video input sources" at right).
- The source can be "hidden" (see "Labeling the video input sources" at right).

### Labeling the video input sources

You can label each video input source according to the type of device you connected to each source, from the following preset list of labels:

- "--" (default label)
- Cable
- DTV
- Satellite/DSS
- VCR
- Laser Disk
- DVD
- Audio Receiver
- Compact Disc
- Video Recorder
- Game Console
- Hide (to hide an unused input in the **Input Selection** screen)

**Note:** If you select **ANT 2** in the **Input selection** screen, you can select either "--" or "Hide".

To label the video input sources:

- 1 Press **MENU** and open the **Preferences** menu.
- 2 Highlight **Input Labeling** and press **ENTER**.
- 3 Press **▲** or **▼** to highlight the video source you want to label.

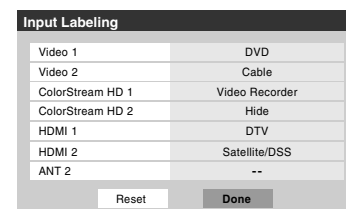
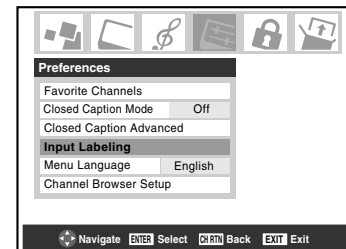

- 4 Press **◀** or **▶** to select the desired label for that input source. If a particular input is not used, you can select **Hide** as the label, which will cause that input to be "grayed out" in the input list and skipped over when you press **INPUT** on the remote control.
- 5 To save the new input labels, highlight **Done** and press **ENTER**. To revert to the factory default labels, highlight **Reset** and press **ENTER**.

(continued)

## Chapter 5: Using the TV's basic features

### Input labeling example:

The screen below left shows the default **Input Selection** screen (with none of the inputs labeled). The screen below right is an example of how you could label the inputs if you had connected a DVD player to VIDEO 1, Cable TV to VIDEO 2, a video recorder to ColorStream HD1, a DTV set-top box to HDMI 1, and a satellite/DSS set-top box to HDMI 2. Also note that the ColorStream HD2 input is labeled "Hidden," which means that the input will be skipped over when **(INPUT)** is pressed.

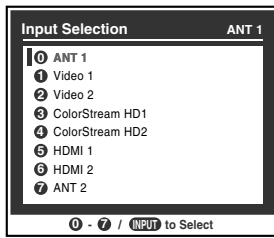

Input Selection screen with no inputs labeled

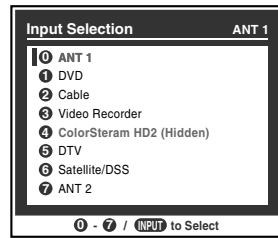

Input Selection screen with all inputs labeled except input 4, which has been hidden.

### To clear the input labels:

- 1 Press **MENU** and open the **Preferences** menu.
- 2 Highlight **Input Labeling** and press **(ENTER)**.
- 3 Highlight **Reset** and press **(ENTER)**.

## Tuning channels

### Using the Channel Browser™

The Channel Browser™ stores the most recently viewed channels or inputs in a history list. In addition, it provides a list of all the available channels on the ANT1 input (up to 2000), the ANT2 input (up to 2000) and a list of all the inputs on the TV. This feature allows you to:

- Keep a history of the last 32 channels or inputs viewed.
- Quickly surf and tune your recently viewed channels/inputs from the Channel Browser™ banner (illustrated on the next page).
- Surf via Browse mode (to immediately tune channels as you highlight them in the Channel Browser™ banner) or Select mode (to surf over channels in the browser banner before you select one to tune).
- Quickly change inputs from the Inputs List.
- Set a "HOME" source for an **ANT1** or **ANT2** channel or TV input.

### To set the Channel Browser™:

- 1 Press **MENU** and open the **Preferences** menu.
- 2 Highlight **Channel Browser Setup** and press **(ENTER)**.
- 3 Press **▲** to highlight **Navigation**, and then press **◀** or **▶** to select either **Browse Mode** or **Select Mode**.

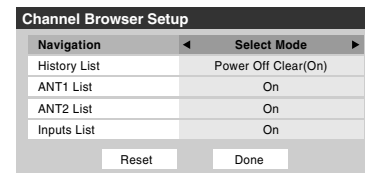

- 4 Press **▼** to highlight **History List** field, then press **◀** or **▶** to select the setting you prefer either **Power Off Clear (On)**, **On** or **Off**.

**Note:** When *History List* is set to **On**, the channels and inputs stored in the list will be saved through power on and off. When *History List* is set to **Power Off Clear (On)**, the channels and inputs stored in the list will be cleared with every power on/off cycle of the TV.

- 5 Press **▼** to highlight **ANT1 List** field, then press **◀** or **▶** to select **On** or **Off**.
- 6 Press **▼** to highlight **ANT2 List** field, then press **◀** or **▶** to select **On** or **Off**.
- 7 Press **▼** to highlight **Inputs List** field, then press **◀** or **▶** to select **On** or **Off**.
- 8 To save your entries, highlight **Done** and press **(ENTER)**. To return to factory defaults, highlight **Reset** and press **(ENTER)**.

## Chapter 5: Using the TV's basic features

### To open the Channel Browser™ banner:

- Press **BACK** ◀, **NEXT** ▶, or **HOME** on the remote control.
- Press **BACK** ◀ to surf back from the most recently viewed channel through the last 32 channels or inputs in the History list, ANT 1 channels list, ANT 2 channels list or the inputs list.
- Press **NEXT** ▶ to surf forward from the previous item in the channel history, ANT 1, ANT 2, or inputs up to the most recently viewed item or end of list.

### Elements of the Channel Browser™ banner

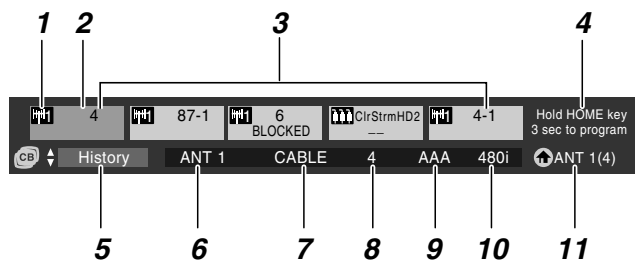

- 1 Input type
- 2 Highlighted item (channel or input)
- 3 Channels stored in the channel history
- 4 Home instructions (this will be replaced once there are at least 6 items in the History, ANT 1 or Inputs lists)
- 5 Current list (**History**, **ANT 1**, **ANT 2** or **Inputs**)
- 6 Current input
- 7 Current antenna type (cable or TV)
- 8 Active channel number
- 9 Channel call letters (if available)
- 10 Resolution
- 11 Home source

### To toggle between History, ANT 1, ANT 2 and Inputs:

After opening the Channel Browser™ banner, press ▲ or ▼ to toggle between **History**, **ANT 1**, **ANT 2** and **Inputs**.

**Note:** The Channel Browser™ banner opens in **History** List by default. Once another list has been selected, the Channel Browser™ will open in the last selected list.

### To tune to a channel or input in Browse mode:

- 1 While watching TV, press **BACK** ◀ or **NEXT** ▶ to open the Channel Browser™ banner and surf back to a previous item or surf forward to the next item in the list.  
In **Browse** mode, when you stop on an item in the browser banner, it will be highlighted and the TV will automatically tune to the channel or input.
- 2 Press **EXIT** to close the Channel Browser™ banner.

**Note:** The Channel Browser™ banner will close automatically if you do not make a selection within 30 seconds.

### To tune to a channel or input in Select mode:

- 1 While watching TV, press **BACK** ◀ or **NEXT** ▶ to open the Channel Browser™ banner and surf back to a previous item or surf forward to the next item in the list.  
In **Select** mode, when you stop on an item in the browser banner, it will be highlighted but the TV will not automatically tune to the channel or input.
- 2 Press **ENTER** to tune the TV to the highlighted item.
- 3 Press **EXIT** to close the Channel Browser™ banner.

### Adding and clearing channels and inputs in the channel history

#### Adding channels and inputs to the channel history:

The Channel Browser™ automatically creates a history of the last 32 channels or inputs that were tuned by adding that channel or input to the right of the list (revisited items are moved to the end of the list).

The Channel Browser™ will store the following channels:

- All channels that are tuned using the numeric buttons on the remote control.
- All channels that are tuned to using **CH** or **CH**, **FAV**▲ or **FAV**▼ on the remote control and inputs that are tuned to for at least 5 seconds.

**Note:** The TV will automatically tune to the previously viewed channel or input whenever an item is selected that cannot be tuned for various reasons.

#### Clearing channels from the channel history:

- Turning off the TV will clear the channel history only if **History List** in the **Channel Browser Setup** is set to **“Power Off Clear (On).”**
- Reconfiguring the **ANT 1** or **ANT 2** input will clear the channel history.
- **Note:** See page 16 for details on configuring the antenna input.
- Removing the CableCARD™ will clear the channel history.
- Once 32 channels or inputs are stored in the history list, the oldest item will be removed from the list when a new channel or input is tuned.

## Chapter 5: Using the TV's basic features

### Using the Home feature

#### To set a channel or input as Home:

- 1 Tune the TV to the channel or input you would like to set as the Home source.
- 2 Press and hold **HOME** on the remote control for 3 seconds. When HOME is saved, the Channel Browser™ banner will appear at the bottom of the screen and the HOME icon will flash green.

#### To tune to HOME:

Press the **HOME** button on the remote to tune to your HOME channel or input. The Channel Browser™ banner will display when HOME is tuned unless all lists have been turned to “Off” in the **Channel Browser Setup**.

**Note:** If all lists are turned to off, Home may not be set at this time; however, if it is already set, pressing the **HOME** button on the remote will tune to the Home source, but will not display the Channel Browser™.

### Tuning your favorite channels

To tune to the channels you programmed as Favorite Channels, see page 18.

#### Tuning to the next programmed channel

##### To tune to the next programmed channel:

Press **CH** or **CH** on the remote control or TV control panel.

**Note:** This feature will not work unless you program channels into the TV's channel memory (see page 17).

#### Tuning to a specific channel (programmed or unprogrammed)

##### Tuning analog channels:

Press the Channel Number buttons (0–9) on the remote control. For example, to select channel 125, press 1, 2, 5.

##### Tuning digital channels:

Press the Channel Number buttons (0–9) on the remote control, followed by the dash (**100**) button and then the sub-channel number. For example, to select digital channel 125-1, press 1, 2, 5, -, 1.

**Note:** If a digital channel is not programmed—either through the automatic channel scan (see page 17) or the channel add/delete function (see page 17)—you will have to tune the RF channel using the Channel Number and the dash (**100**) buttons on the remote control.

### Switching between two channels using Channel Return

The Channel Return feature allows you to switch between two channels without entering an actual channel number each time.

- 1 Select the first channel you want to view.
- 2 Select a second channel using the Channel Number buttons (and the dash (**100**) button if selecting a digital channel).
- 3 Press **CH RTN** on the remote control. The previous channel will display. Each time you press **CH RTN**, the TV will switch back and forth between the last two channels that were tuned.

**Note:** If you press **CH RTN** from a non-antenna input, the TV will return to the last-viewed ANT input and channel.

### Switching between two channels using SurfLock™

The SurfLock™ feature temporarily “memorizes” one channel in the **CH RTN** button, so you can return to that channel quickly from any other channel by pressing **CH RTN**. To memorize a channel in the **CH RTN** button:

- 1 Tune the TV to the channel you want to program into the **CH RTN** button.
- 2 Press and hold **CH RTN** for about 2 seconds until the message “Channel Memorized” appears on the screen. The channel has been programmed into the **CH RTN** button.
- 3 You can then change channels repeatedly, and when you press **CH RTN**, the memorized channel will be selected.

The TV will return to the memorized channel one time only. Once you press **CH RTN** and then change channels again, the CH RTN memory will be cleared and the button will function as Channel Return, by switching back and forth between the last two channels that were tuned.

**Chapter 5: Using the TV's basic features**

**Selecting the picture size**

You can view many program formats in a variety of picture sizes—**Natural**, **TheaterWide 1**, **TheaterWide 2**, **TheaterWide 3**, and **Full**.

The way the image displays in any of the picture sizes will vary depending on the format of the program you are viewing. Select the picture size that displays the current program the way that looks best to you.

Your picture size preferences can be saved for each input on your TV.

**To select the picture size:**

- 1 Press **PIC SIZE** on the remote control.
- 2 While the **Picture Size** screen is on-screen, press the corresponding number button (0–4) to select the desired picture size.

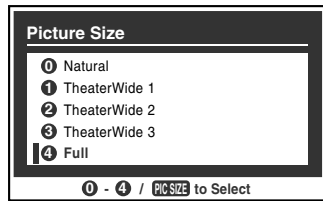

**Notes:**

- You also can repeatedly press **PIC SIZE** to select the desired picture size (or press **▲▼** on the remote control while the **Picture Size** screen is open).
- **Full** may not be available for some program formats (it will be "grayed out" in the **Picture Size** screen).
- You also can select the picture size using the menu system. Select **Picture Size** in the **Theater Settings** menu. Select the input for which you want to save your picture settings. To save your settings, highlight **Done** and press **ENTER**.

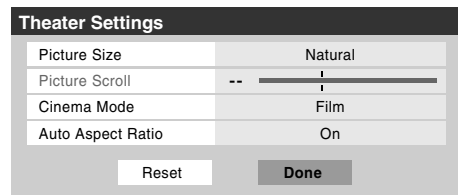

Using these functions to change the picture size (i.e., changing the height/ width ratio) for any purpose other than your private viewing may be prohibited under the Copyright Laws of the United States and other countries, and may subject you to civil and criminal liability.

**Natural picture size**

- The image is displayed close to its originally formatted proportion. Some program formats will display with sidebars and/or bars at the top and bottom. Natural picture size example: The way the image displays will vary depending on the format of the program you are currently watching.

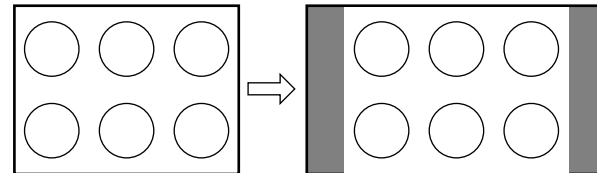

Conventional picture on a conventional TV screen

Conventional picture in Natural size on your wide-screen TV

**TheaterWide 1 picture size (For 4:3 format program)**

- The center of the picture remains close to its original proportion, but the left and right edges are stretched wider to fill the screen.

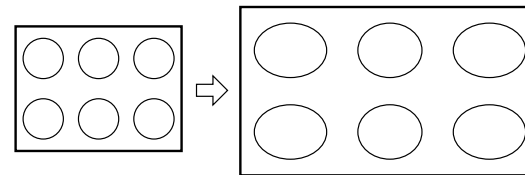

TheaterWide 1 picture size example

**TheaterWide 2 picture size (for letter box programs)**

- The picture is stretched wider to fill the width of the screen, but only slightly stretched taller.
- The top and bottom edges of the picture are hidden. To view the hidden areas, see "Scrolling the TheaterWide® picture" (page 28).

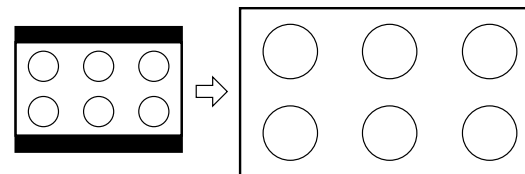

TheaterWide 2 picture size example

(continued)

## Chapter 5: Using the TV's basic features

### TheaterWide 3 picture size (for letter box programs with subtitles)

- The picture is stretched wider to fill the width of the screen, but only slightly stretched taller.
- The top and bottom edges are hidden. To view the hidden areas (such as subtitles or captions), see “Scrolling the TheaterWide® picture”.

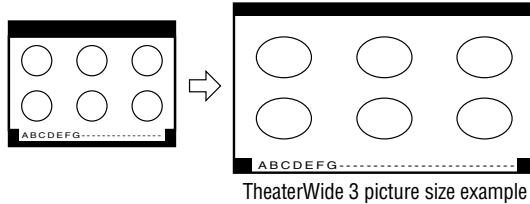

### Full picture size (for 16:9 [480i, 480p] source programs only)

- If receiving a squeezed 4:3 format program, the picture is stretched wider to fill the width of the screen, but not stretched taller.
- None of the picture is hidden.

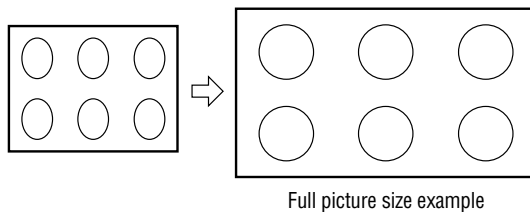

#### Notes:

- If you select one of the TheaterWide® picture sizes, the top and bottom edges of the picture (including subtitles or captions) may be hidden. To view the hidden edges, either scroll the picture (**TheaterWide 2 and 3** only) or try viewing the program in **Full** or **Natural** picture size.
- When selecting the picture size, the way the image displays will vary depending on the format of the program you are currently watching.

## Scrolling the TheaterWide® picture (TheaterWide 2 and 3 only)

You can set separate scroll settings for the TheaterWide 2 and TheaterWide 3 modes for each input.

### To set the scroll settings:

- 1 Press **MENU** and open the **Video** menu.
- 2 Highlight **Theater Settings** and press **ENTER**.

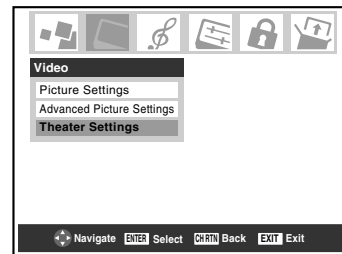

- 3 In the **Picture Size** field, select either **TheaterWide 2** or **TheaterWide 3** (you cannot scroll in any other mode).
- 4 Press **▼** to highlight the **Picture Scroll** field.
- 5 Press **◀** or **▶** to scroll the picture up and down as needed, from -10 to +20.

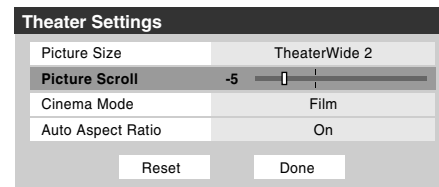

- 6 To save the new settings, highlight **Done** and press **ENTER**. To revert to the factory defaults, highlight **Reset** and press **ENTER**.



## Chapter 5: Using the TV's basic features

### Using the auto aspect ratio feature

When the auto aspect ratio feature is set to **On**, the picture size is automatically selected when one of the following input sources is received:

- A 480i signal from the **VIDEO 1**, **VIDEO 2**, **ColorStream HD-1**, or **ColorStream HD-2** input.
- A 1080i, 480i, 480p, or 720p signal from the **HDMI** input.

Aspect ratio of signal source	Automatic aspect size (automatically selected when Auto Aspect is On)
4:3 normal	Natural (with sidebars)
4:3 letter box	TheaterWide 2
16:9 full	Full
Not defined (no ID-1 data or HDMI aspect data)	Selecting the picture size (see page 27)

**Note:** The auto aspect ratio feature is not applicable to antenna or cable input sources.

#### To turn on the auto aspect ratio feature:

- 1 Press **MENU** and open the **Video** menu.
- 2 Highlight **Theater Settings** and press **ENTER**.
- 3 In the **Auto Aspect Ratio** field, select **On**.

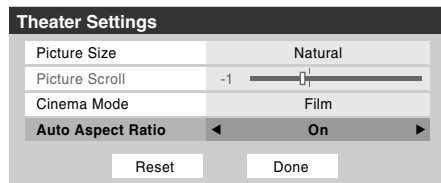

- 4 To save the new settings, highlight **Done** and press **ENTER**. To revert to the factory defaults, highlight **Reset** and press **ENTER**.

#### To turn off the auto aspect ratio feature:

Select **Off** in step 3 above.

### Selecting the cinema mode (480i signals only)

When you view a DVD (480i signal; 3:2 pulldown processed) from a DVD player connected to the **VIDEO 1**, **VIDEO 2**, **ColorStream HD-1/HD-2** (component video), or **HDMI** inputs on the TV, smoother motion can be obtained by setting the **Cinema Mode** to **Film**.

#### To set the Cinema Mode to Film:

- 1 Press **MENU** and open the **Video** menu.
- 2 Highlight **Theater Settings** and press **ENTER**.
- 3 In the **Cinema Mode** field, select **Film**.

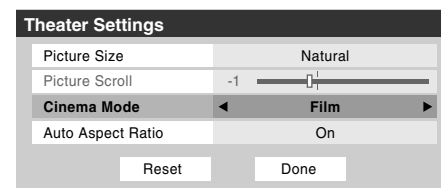

- 4 To save the new settings, highlight **Done** and press **ENTER**. To revert to the factory defaults, highlight **Reset** and press **ENTER**.

#### To set the Cinema Mode to Video:

Select **Video** in step 3 above.



## Chapter 5: Using the TV's basic features

### Adjusting the picture

#### Selecting the picture mode

You can select your desired picture settings from four different modes, as described below.

Mode	Picture Quality
Sports	Bright and dynamic picture (factory setting)
Standard	Standard picture settings (factory setting)
Movie	Lower contrast for darkened room (factory setting)
Preference	Your personal preferences

#### To select the picture mode using the menu system:

- 1 Press **MENU** and open the **Video** menu.
- 2 Highlight **Picture Settings** and press **ENTER**.
- 3 In the **Mode** field, select the picture mode you prefer.

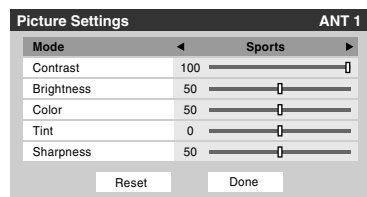

- 4 To save the new settings, highlight **Done** and press **ENTER**. To revert to the factory defaults, highlight **Reset** and press **ENTER**.

#### Notes:

- The picture mode you select affects the current input only (ANT 1 in the example above). You can select a different picture mode for each input.
- If you select one of the factory-set picture modes (**Sports**, **Standard**, or **Movie**) and then change a picture quality setting (for example, increase the contrast or change the color temperature), the picture mode automatically changes to **Preference** in the **Picture Settings** menu.
- If you have previously set the TV to **High Bright** mode, and have chosen **Reset** in item 4 above, the TV will default to **Low Power** mode. To set the TV back to **High Bright** mode, see page 42.

### Adjusting the picture quality

You can adjust the picture quality (contrast, brightness, color, tint, and sharpness) to your personal preferences.

Selection	Pressing ◀	▶ Pressing
contrast	lower	higher
brightness	darker	lighter
color	paler	deeper
tint	reddish	greenish
sharpness	softer	sharper

#### To adjust the picture quality:

- 1 Press **MENU** and open the **Video** menu.
- 2 Highlight **Picture Settings** and press **ENTER**.
- 3 Press **▲** or **▼** to select the picture quality you want to adjust (**Contrast**, **Brightness**, **Color**, **Tint**, or **Sharpness**), and then press **◀** and **▶** to adjust the setting, as described in the table above.

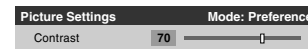
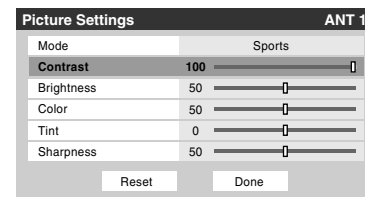

- 4 To save the new settings, highlight **Done** and press **ENTER**. To revert to the factory defaults, highlight **Reset** and press **ENTER**.

The picture qualities you adjusted are automatically saved in the **Preference** mode (see “Selecting the picture mode,” above left).

**Chapter 5: Using the TV's basic features**

**Using the closed caption mode**

The closed caption mode has two options:

- **Captions**—An on-screen display of the dialogue, narration, and sound effects of TV programs and videos that are closed captioned (usually marked “CC” in program guides).
- **Text**—An on-screen display of information not related to the current program, such as weather or stock data (when provided by individual stations).

**To view captions or text:**

- 1 Press **MENU** and open the **Preferences** menu.
- 2 Highlight **Closed Caption Mode** and press **▶**.
- 3 Press **▲** or **▼** to select the desired closed caption mode and press **ENTER**.

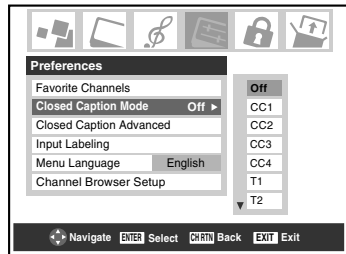

- **To view captions:** Highlight **CC1**, **CC2**, **CC3**, or **CC4**. (**CC1** displays translation of the primary language in your area.)



**Note:** If the program or video you selected is not closed captioned, no captions will display on-screen.

- **To view text:** Highlight **T1**, **T2**, **T3**, or **T4**.

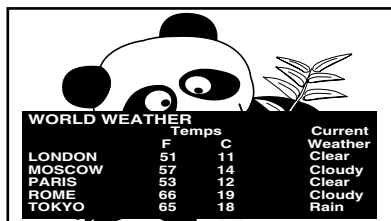

**Note:** If text is not available in your area, a black rectangle may appear on your screen. If this happens, turn the Closed Caption Mode Off.

- **To turn off the Closed Caption mode:** Select **Off** in step 3 above.

**Note:** A closed caption signal may not display in the following situations:

- When a videotape has been dubbed
- When the signal reception is weak
- When the signal reception is non-standard

**Closed Caption Advanced**

You can customize the closed caption display characteristics by changing the text size, type, edge, color, and the background color. You cannot set the Caption Text and Background as the same color.

**Notes:**

- This feature is available for digital channels only.
- You cannot set the Caption Text and Background as the same color.

**To customize the closed captions:**

- 1 Press **MENU** and open the **Preferences** menu.
- 2 Highlight **Closed Caption Advanced** and press **ENTER**.
- 3 Press **▲** or **▼** to highlight the characteristic you want to change, and then press **◀** or **▶** to select the format for that characteristic.

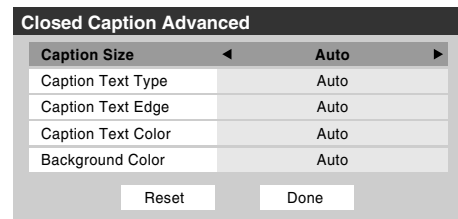

- 4 To save the new settings, highlight **Done** and press **ENTER**. To revert to the factory defaults, highlight **Reset** and press **ENTER**.

Caption Size	Auto, Small, Standard, Large
Caption Text Type	Auto, Default, Mono w. Serif, Prof. w. Serif, Mono w/o Serif, Prop w/o Serif, Casual, Cursive, Small Capitals
Caption Text Edge	Auto, None, Raised, Depressed, Uniform, Left Drop Shadow, Right Drop shadow
Caption Text Color	Auto, Black, White, Red, Green, Blue, Yellow, Magenta, Cyan
Background Color	Auto, Black, White, Red, Green, Blue, Yellow, Magenta, Cyan

## Chapter 5: Using the TV's basic features

### Digital closed captions

You can use the **Digital CC/Audio Selector** to select digital closed caption services (if available), which will temporarily override closed captions for digital channels only.

When such services are not available, the **Digital CC/Audio Selector** presents a default list of services. If the selected service is not available, the next best service will be used instead.

#### To select digital closed captions:

- 1 Press **MENU** and open the **Applications** menu.
- 2 Highlight **Digital CC/Audio Selector** and press **ENTER**.

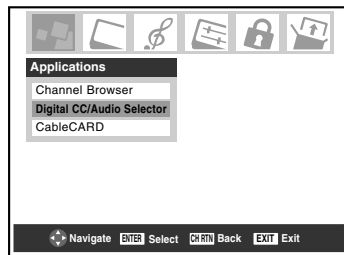

- 3 Press **▲** or **▼** to select **Closed Caption**, and then press **◀** or **▶** to select the desired service.



- 4 Press **EXIT**.

### Adjusting the audio

#### Muting the sound

Press **MUTE** to partially reduce (1/2 MUTE) or turn off (MUTE) the sound. Each time you press **MUTE**, the mute mode will change in the following order:



If the closed caption mode is set to **Off** when you select "MUTE" mode, the closed caption feature is automatically activated. To mute the audio without automatically activating the closed caption feature, use **VOL** to set the volume to 0. See "Using the closed caption mode" (page 31) for more information on closed caption modes.

#### Using the digital audio selector

You can use the **Digital CC/Audio Selector** to conveniently switch between audio tracks on a digital channel (for those channels that have multiple audio tracks). This temporarily overrides the audio track chosen by the language option under **Audio Setup** (see "Selecting stereo/SAP broadcasts," on page 33).

#### To use the digital audio selector:

- 1 Press **MENU** and open the **Applications** menu.
- 2 Highlight **Digital CC/Audio Selector** and press **ENTER**.

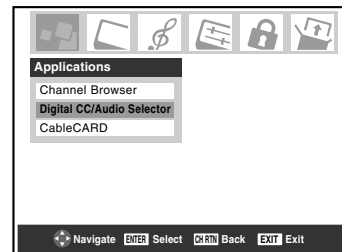

- 3 Press **▲** or **▼** to select **Audio**, and then press **◀** or **▶** to select the desired service.



- 4 Press **EXIT**.

## Chapter 5: Using the TV's basic features

### Selecting stereo/SAP broadcasts

The multi-channel TV sound (MTS) feature allows you to output high-fidelity stereo sound. MTS also can transmit a second audio program (SAP) containing a second language, music, or other audio information (when provided by individual stations).

The MTS feature is not available when the TV is in VIDEO mode. When the TV receives a stereo or SAP broadcast, the word "STEREO" or "SAP" appears on-screen when **RECALL** is pressed.

#### To listen to stereo sound:

- 1 Press **MENU** and open the **Audio** menu.
- 2 Highlight **Audio Setup** and press **ENTER**.

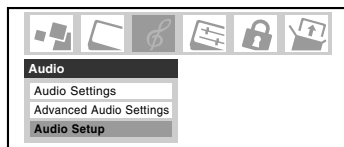

- 3 In the **MTS** field, select **Stereo**.

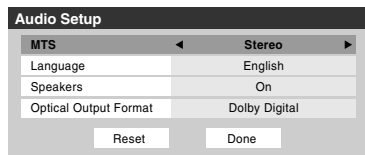

- 4 To save the new settings, highlight **Done** and press **ENTER**. To reset the settings to the factory defaults, highlight **Reset** and press **ENTER**.

#### Notes:

- If you leave the TV in **Stereo** mode because it will automatically output the type of sound being broadcast (stereo or monaural).
- If the stereo sound is noisy, select **Mono** to reduce the noise.

#### To listen to an alternate language on an ATSC digital station (if available):

Highlight the **Language** field in step 3 above, and then press **◀** or **▶** to select the language you prefer.

#### To listen to a second audio program on an analog station (if available):

Select **SAP** in step 3 above.

#### Notes:

- A second audio program (SAP) can be heard only on those TV stations that offer it. For example, a station might broadcast another language as a second audio program. If you have SAP on, you will see the current program on the screen but hear the other language instead of the program's normal audio.

- If you have SAP on and the station you are watching is not broadcasting a second audio program, the station's normal audio will be output. However, occasionally there is no sound at all in **SAP** mode. If this happens, set the **MTS** feature to **Stereo** mode.

### Adjusting the audio quality

You can adjust the audio quality by adjusting the bass, treble, and balance.

#### To adjust the audio quality:

- 1 Press **MENU** and open the **Audio** menu.
- 2 Highlight **Audio Settings** and press **ENTER**.
- 3 Press **▼** or **▲** to highlight the item you want to adjust (**Bass**, **Treble**, or **Balance**).

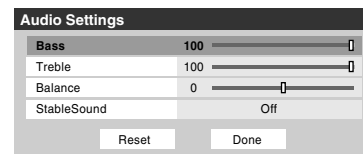

- 4 Press **◀** or **▶** to adjust the level.
  - **◀** makes the bass or treble weaker or increases the balance in the left channel (depending on the item selected).
  - **▶** makes the bass or treble stronger or increases the balance in the right channel (depending on the item selected).
- 5 To save the new settings, highlight **Done** and press **ENTER**. To reset the settings to the factory defaults, highlight **Reset** and press **ENTER**.

## Chapter 5: Using the TV's basic features

### Using the StableSound® feature

The StableSound® feature limits the highest volume level to prevent extreme changes in volume when the signal source changes (for example, to prevent the sudden increase in volume that often happens when a TV program switches to a commercial).

#### To turn on the StableSound® feature:

- 1 Press **MENU** and open the **Audio** menu.
- 2 Highlight **Audio Settings** and press **ENTER**.
- 3 In the **StableSound** field, select **On**.

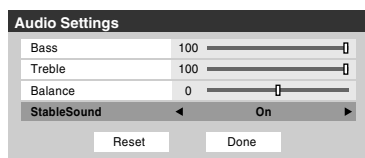

- 4 To save the new settings, highlight **Done** and press **ENTER**. To revert to the factory defaults, highlight **Reset** and press **ENTER**.

**Note:** The **RESET** function returns your audio adjustments to the following factory settings:

Bass . . . . . center (50)  
 Treble. . . . . center (50)  
 Balance . . . . . center (0)  
 StableSound. . . Off

#### To turn off the StableSound feature:

Select **Off** in step 3 above.

### Turning off the built-in speakers

You can use this feature to turn off the TV speakers when you connect an audio system to your TV (see “Connecting a digital audio system” and “Connecting an analog audio system” in the *Installation Guide*).

#### To turn off the built-in speakers:

- 1 Press **MENU** and open the **Audio** menu.
- 2 Highlight **Audio Setup** and press **ENTER**.
- 3 In the **Speakers** field, select **Off**.

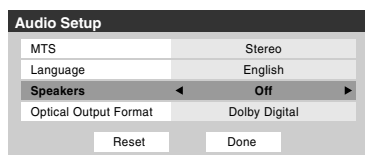

- 4 To save the new settings, highlight **Done** and press **ENTER**. To revert to the factory defaults, highlight **Reset** and press **ENTER**.

#### To turn on the built-in speakers:

Select **On** in step 3 above.

### Selecting the optical audio output format

You can use this feature to select the optical audio output format when you connect a Dolby Digital decoder or other digital audio system to the **Optical Audio Out** terminal on the TV

(see “Connecting a digital audio system” in the *Installation Guide*).

#### To select the optical audio output format:

- 1 Press **MENU** and open the **Audio** menu.
- 2 Highlight **Audio Setup** and press **ENTER**.
- 3 In the **Optical Output Format** field, select either **Dolby Digital** or **PCM**, depending on your device.

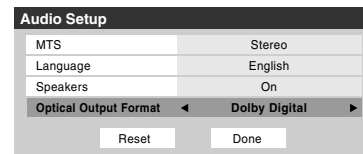

- 4 To save the new settings, highlight **Done** and press **ENTER**. To revert to the factory defaults, highlight **Reset** and press **ENTER**.

## Chapter 5: Using the TV's basic features

### Using the Locks menu

The Locks menu includes the Enable Rating Blocking, Edit Rating Limits, Channels Block, Input Lock, Front (control) Panel Lock, and New PIN Code features. You can use these features after entering the correct PIN code.

### Entering the PIN code

- 1 Press **MENU** and highlight the **Locks** menu icon.

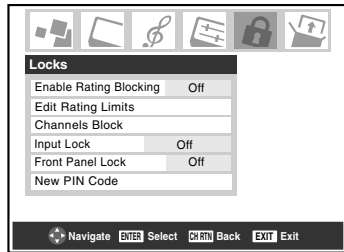

- 2 Press **▼**, which displays the PIN code entry screen.
  - The **Lock System** screen (below) appears if a PIN code has not been stored. Press the Channel Number buttons to enter a new four-digit code, enter the code a second time to confirm, and press **ENTER**.

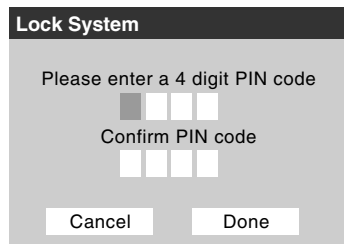

- The **Locks/Active** screen (below) appears if the PIN code is already stored. Use the Number buttons to enter your four-digit code and press **ENTER**.

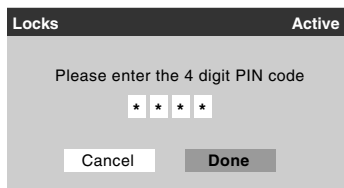

If the wrong PIN code is entered, the message "Incorrect PIN code, please try again!" appears. Highlight **Retry** and press **ENTER**. Enter the code again and press **ENTER**.

When the correct PIN code is entered, the **Locks** menu opens.

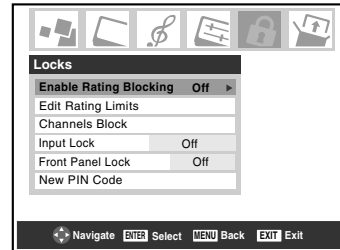

### If you cannot remember your PIN code

While the PIN code entering screen is displayed, press **RECALL** four times within five seconds. The PIN code will be cleared and you can enter a new PIN code.

### Changing your PIN code

- 1 Press **MENU** and highlight the **Locks** menu icon.
- 2 Press **▼** to display the PIN code entering screen.
- 3 Enter your four-digit PIN code and press **ENTER**.
- 4 Press **▼** to highlight **New PIN Code** and press **ENTER**.

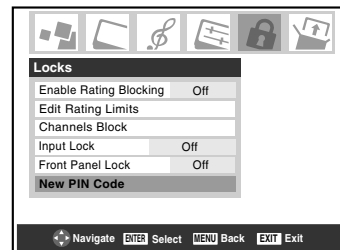

- 5 Press the Number buttons to enter a new four-digit code. Retype the numbers to confirm the PIN code you entered.
- 6 Press **ENTER**. The new PIN code is now active.

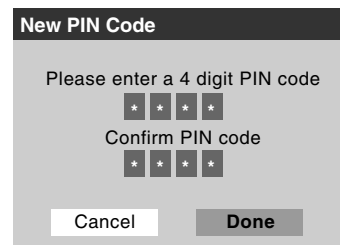



**Chapter 5: Using the TV's basic features**

**Blocking TV programs and movies by rating (V-Chip)**

Some TV programs and movies include signals that classify the content of the program (violence, sex, dialog, language). The V-Chip feature in this TV detects the signals and blocks the programs according to the ratings you select. (See the tables at below right for rating descriptions.)

*Note: Rating blocking is a function of the V-Chip feature in this TV, which supports the U.S. V-Chip system only.*

**To block and unblock TV programs and movies:**

- 1 Press **MENU** and highlight the **Locks** menu icon.
- 2 Press **▼** to display the PIN code entering screen.
- 3 Enter your four-digit PIN code and press **ENTER**.
- 4 Press **▼** to highlight **Enable Rating Blocking**.
- 5 Press **▶** and **▼** to select **On**, and press **ENTER**.

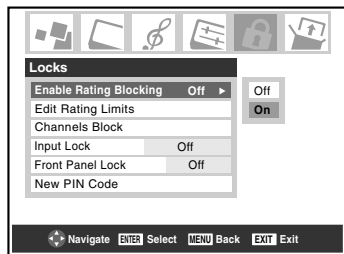

- 6 Press **▼** to highlight **Edit Rating Limits** and press **ENTER**. The **Edit Rating Limits** screen (below) appears.
- 7 Press **▲▼◀▶** and then press **ENTER** to select the level of blocking you prefer. A box with an "X" is a rating that will be blocked. As you highlight a rating, a definition for the rating appears at the bottom of the screen.
- 8 When done selecting the ratings you want to block, highlight **Done** and press **ENTER**.

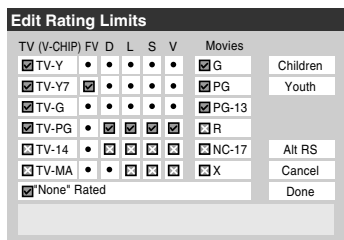

**Blocking TV programs and movies by alternate ratings:**

The alternate rating system is provided by some broadcasters as a supplement the standard V-Chip ratings. This system is dependant on the broadcaster's information.

- 1 Repeat steps 1-6 above.

- 2 Highlight **Alt RS** and press **ENTER**. The **Edit Alternate Ratings** screen will appear. (This button will only be available if your television has detected that the broadcaster is send alternate ratings with that program.)
- 3 Press **▲▼◀▶** and then press **ENTER** to select the level of blocking you prefer. A box with and "X" is a rating that will be blocked. (The information contained within this menu window will depend on what the broadcaster is providing.)
- 4 When done selecting the ratings you want to block, highlight **Done** and press **ENTER**.
- 5 In the **Edit Rating Limits** screen, highlight **Done** and press **ENTER**.

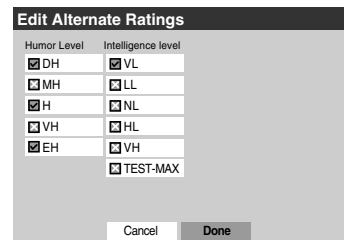

*Note: The above illustration is example data only. The **Alternate Ratings** screen on your TV may not look the same.*

Independent rating system for broadcasters	
Ratings	Description and Content themes
<b>TV-MA</b>	Mature Audience Only (This program is specifically designed to be viewed by adults and therefore may be unsuitable for children under 17.) <b>L)</b> Crude or indecent language <b>S)</b> Explicit sexual activity <b>V)</b> Graphic violence
<b>TV-14</b>	Parents Strongly Cautioned (This program contains some material that many parents would find unsuitable for children under 14 years of age.) <b>D)</b> Intensely suggestive dialog <b>L)</b> Strong, coarse language <b>S)</b> Intense sexual situations <b>V)</b> Intense violence
<b>TV-PG</b>	Parental Guidance Suggested (This program contains material parents may find unsuitable for younger children.) <b>D)</b> Some suggestive dialog <b>L)</b> Infrequent coarse language <b>S)</b> Some sexual situations <b>V)</b> Moderate violence
<b>TV-G</b>	General Audience (Most parents would find this program suitable for all ages.)
<b>TV-Y7, TV-Y7FV</b>	Directed to Older Children (This program is designed for children age 7 and above. Note: Programs in which fantasy violence may be more intense or more combative than other programs in this category are designated Y7FV.)
<b>TV-Y</b>	All Children (This program is designed to be appropriate for all children.)



**Chapter 5: Using the TV's basic features**

Independent rating system for movies	
Ratings	Description and Content themes
<b>X</b>	X-rated (For adults only)
<b>NC-17</b>	Not intended for anyone 17 and under
<b>R</b>	Restricted (Under 17 requires accompanying parent or adult)
<b>PG-13</b>	Parents Strongly Cautioned (Some material may be inappropriate for children under 13)
<b>PG</b>	Parental Guidance Suggested (Some material may not be suitable for children)
<b>G</b>	General Audience (Appropriate for all ages)

**Notes:**

- If you place an "X" in the box next to "None Rated," programs rated "None" will be blocked; however, programs that do not provide any rating information will not be blocked.
- To display the rating of the program you are watching, press **RECALL** on the remote control. If it is rated "None," the word "NONE" appears in the **RECALL** screen (as shown below right). If rating information is not provided, no rating will appear in the **RECALL** screen.

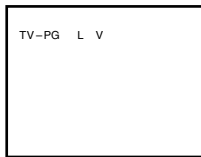

**Blocking channels**

With the Channels Block feature, you can block specific channels. You will not be able to tune blocked channels unless you clear the setting first.

**To block channels:**

- 1 Press **MENU** and highlight the **Locks** menu icon.
- 2 Press **▼** to display the PIN code entering screen.
- 3 Enter your four-digit PIN code and press **ENTER** (see page 35).
- 4 Press **▼** to highlight **Channels Block** and then press **ENTER**.

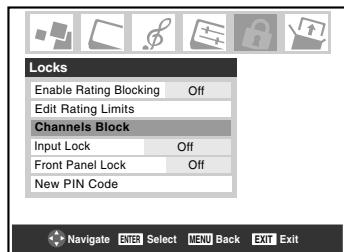

- 5 Using **▲▼◀▶** buttons, select the input for which you want to change the rating limits (**ANT1**, or **ANT2**) and press **ENTER**.

A list of the channels available for that input will be displayed along with the call letters for each channel, if available.

- 6 Press **▲▼** to highlight the channel you want to block, and press **ENTER**, which puts an "X" in the box next to that channel.

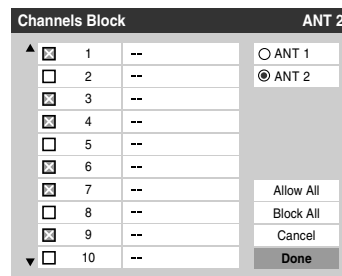

- 7 Repeat step 6 for other channels you want to block.

- 8 Highlight **Done** and press **ENTER**.

**To unblock individual channels:**

In step 6 above, press **▲▼** to highlight the channel you want to unblock, and then press **ENTER** to remove the "X" from the box, and then highlight **Done**, and then press **ENTER**.

**To block all channels at once:**

Highlight **Block All** in step 6 above, and then highlight **Done**, and press **ENTER**.

**To unblock all locked channels at once:**

Highlight **Allow All** in step 6 above, and then highlight **Done** and press **ENTER**.

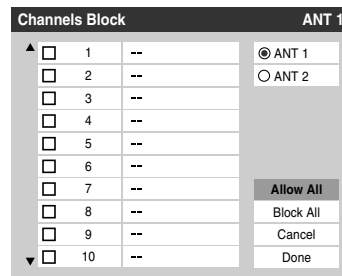

(continued)

## Chapter 5: Using the TV's basic features

### Unlocking programs temporarily

If you try to tune the TV to a program that exceeds the rating limits you set, the TV will enter program lock mode and the following message will appear on-screen:

This program exceeds the rating limit you set.  
Push 'mute' to enter PIN.

You can either temporarily unlock the program or select an unlocked program to watch.

#### To temporarily unlock the program:

- 1 Press **MUTE**.
- 2 Enter your four-digit PIN code and press **ENTER**. If the correct code is entered, the program lock mode is released and the normal picture appears. All locking is disabled until the TV is turned off, and will be enabled when the TV is turned on again.

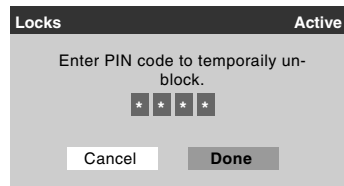

### Using the input lock feature

You can use the Input Lock feature to lock the video inputs (**VIDEO 1, VIDEO 2, ColorStream HD-1, ColorStream HD-2, HDMI 1, and HDMI 2**) and channels 3 and 4. You will not be able to view the input sources or channels until you unlock the inputs.

#### To lock/unlock the video inputs:

- 1 Press **MENU** and highlight the **Locks** menu icon.
- 2 Press **▼** to display the PIN code entering screen.
- 3 Enter your four-digit PIN code and press **ENTER**.
- 4 Press **▼** to highlight **Input Lock** and press **▶**.
- 5 Press **▲** or **▼** to select the level of video input locking you prefer, as described below.

**Video:** Locks VIDEO 1, VIDEO 2, ColorStream HD1/HD2, HDMI 1/HDMI 2.

**Video+:** Locks VIDEO 1, VIDEO 2, ColorStream HD1/HD2, HDMI 1/HDMI 2, and channels 3 and 4.

- Select Video+ if you play video tapes via an ANT input.
- When a CableCARD™ is inserted, Video+ will not lock channels 3 and 4.

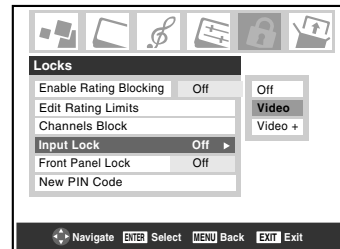

**Off:** Unlocks all video inputs and channels 3 and 4.

- 6 Press **ENTER**.

## Chapter 5: Using the TV's basic features

### Using the control panel lock feature

You can lock the control panel to prevent your settings from being changed accidentally (by children, for example). When the control panel lock is **On**, none of the controls on the TV control panel will operate except **POWER**.

#### To lock the control panel:

- 1 Press **MENU** and highlight the **Locks** menu icon.
- 2 Press **▼** to display the PIN code entering screen.
- 3 Enter your four-digit PIN code and press **ENTER**.
- 4 Press **▼** to highlight **Front Panel Lock**.
- 5 Press **▶** and **▲** or **▼** to highlight **On** and press **ENTER**. When the control panel is locked and a button on the control panel except **POWER** button is pressed, the message "NOT AVAILABLE" appears.

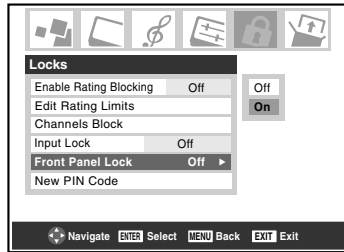

#### To unlock the control panel:

Highlight **Off** in step 5 above, or press and hold the **VOLUME –** button on the TV control panel for about 10 seconds until the volume icon appears on-screen.

### Setting the sleep timer

You can set the sleep timer to turn off the TV after a set length of time (maximum of 180 minutes).

#### To set the sleep timer:

Press **SLEEP** on the remote control to set the length of time until the TV turns off. Repeatedly press **SLEEP** to increase the time in 10-minute increments or press **▲** or **▼** to increase or decrease the time in 10-minute increments, to a maximum of 180 minutes.

#### To cancel the sleep timer:

Press **SLEEP** until it is set to 0 minutes.

#### To set the sleep timer using the on-screen menus:

- 1 Press **MENU** and open the **Setup** menu.
- 2 Highlight **Sleep Timer** and press **ENTER**.

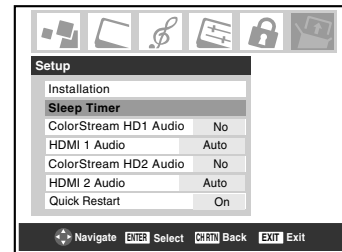

- 3 Press the Number buttons to enter the length of time in 10-minute increments.

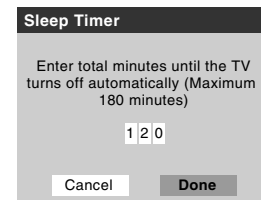

- 4 Highlight **Done** and press **ENTER**.

#### Notes:

- When a power failure occurs, the sleep timer setting may be cleared.
- To display the amount of time left on the sleep timer, press **RECALL**.

#### To display the remaining sleep time:

Press **SLEEP**.

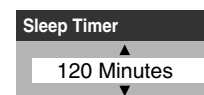

**Note:** A message will display on-screen when there is one minute remaining on the sleep timer.

## Chapter 5: Using the TV's basic features

### Displaying TV setting information on-screen using RECALL

#### To display TV setting information on-screen:

Press  on the remote control.

The following information will display on-screen (if applicable):

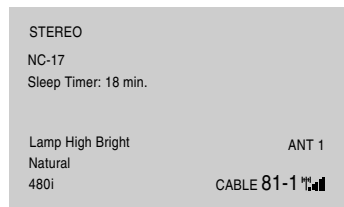

Sample RECALL screen

- Current input (**ANT 1**, **ANT 2**, **VIDEO 1**, etc.)
- If **ANT 1** or **ANT 2** is the current input, whether it is Cable TV (“**CABLE**”) or off-air (“**TV**”)
- Channel number (if in **ANT 1** or **ANT 2** mode)
- Signal strength indicator (bar graph in lower right corner of screen; for ATSC signal only)

**Note:** The signal strength indicator will react to fading and increasing signals.

- Remaining time on sleep timer (if set)
- Stereo or SAP audio status
- V-Chip rating status
- Picture size
- Video resolution
- Lamp mode (appears only if the TV is in High Bright mode)

#### To close the RECALL screen:

Press  again.

### Understanding the auto power off feature

The TV will automatically turn itself off after approximately 15 minutes if it is tuned to a vacant channel or a station that completes its broadcast for the day. This feature functions in **ANT 1** and **ANT 2** modes only.

### Understanding the last mode memory feature

**If the power is cut off while you are viewing the TV, the Last Mode Memory feature automatically turns on the TV when the power is resupplied.**

**Note:** You should unplug the TV's power cord if it is possible that you will be away from the TV for an extended period of time after the power is restored.

## Chapter 6: Using the TV's advanced features

### Using the advanced picture settings features

#### Using dynamic contrast

When dynamic contrast is set to **On**, the TV will detect changes in the picture quality that affect the appearance of your contrast settings and then automatically adjust the video.

When dynamic contrast is set to **Off**, the settings selected in the **Contrast** field in **Picture Settings** will be used.

#### To select dynamic contrast preferences:

- 1 Press **MENU** and open the **Video** menu.
- 2 Highlight **Advanced Picture Settings** and press **ENTER**.
- 3 In the **Dynamic Contrast** field, select either **On** or **Off**.

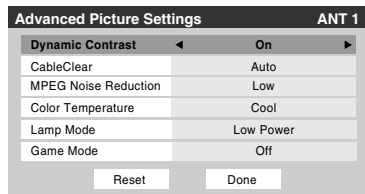

- 4 To save the new settings, highlight **Done** and press **ENTER**. To revert to the factory defaults, highlight **Reset** and press **ENTER**.

**Note:** If you select the **Movie** picture mode and then set the dynamic contrast to **On**, the picture mode will automatically change to **Preference** in the **Picture Settings** menu.

#### Using CableClear®/DNR (digital noise reduction)

The CableClear® digital noise reduction feature allows you to reduce visible interference in your TV picture. This may be useful when receiving a broadcast with a weak signal (especially a Cable channel) or playing a noisy video cassette or disc.

#### To change the CableClear/DNR settings:

- 1 Press **MENU** and open the **Video** menu.
- 2 Highlight **Advanced Picture Settings** and press **ENTER**.
- 3 In the **CableClear/DNR** field, select your desired setting.

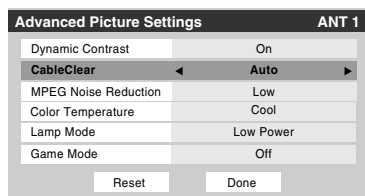

#### Notes:

- If the current input is **ANT 1**, **ANT 2**, **VIDEO 1**, or **VIDEO 2**, the menu will display the text "CableClear." The available selections are **Off**, **Low**, **Middle**, **High**, and **Auto**.
- If the current input is **ColorStream HD1**, **ColorStream HD2**, or **HDMI**, the menu will display the text **DNR**. The available selections are **Off**, **Low**, **Middle**, **High** and **Auto**. **Auto** will react proportionally to the strength of the noise. **Low**, **Middle**, and **High** will reduce the noise in varying degrees, from lowest to highest, respectively.

- 4 To save the new settings, highlight **Done** and press **ENTER**. To revert to the factory defaults, highlight **Reset** and press **ENTER**.

#### Using MPEG noise reduction

The MPEG noise reduction feature allows you to reduce visible interference caused by MPEG compression. Choices for MPEG noise reduction are **Off**, **Low**, **Middle**, and **High**. **Off** is automatically selected when this feature is disabled ("grayed out").

#### To select the MPEG noise reduction level:

- 1 Press **MENU** and open the **Video** menu.
- 2 Highlight **Advanced Picture Settings** and press **ENTER**.
- 3 Press **▲** or **▼** to highlight the **MPEG Noise Reduction** field, and then press **◀** or **▶** to select either **Off**, **Low**, **Middle** or **High**.

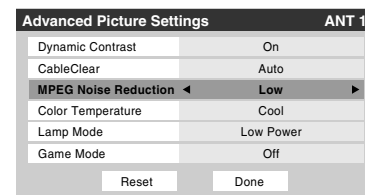

- 4 To save the new settings, highlight **Done** and press **ENTER**. To revert to the factory defaults, highlight **Reset** and press **ENTER**.

(continued)

## Chapter 6: Using the TV's advanced features

### Selecting the color temperature

You can change the quality of the picture by selecting from three preset color temperatures (cool, medium, and warm), as described below.

Mode	Picture Quality
cool	blueish
medium	neutral
warm	reddish

#### To select the color temperature:

- 1 Press **MENU** and open the **Video** menu.
- 2 Highlight **Advanced Picture Settings** and press **ENTER**.
- 3 In the **Color Temperature** field, select the mode you prefer (**Cool**, **Medium**, or **Warm**).

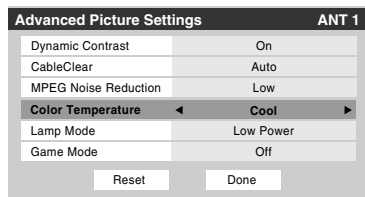

- 4 To save the new settings, highlight **Done** and press **ENTER**. To revert to the factory defaults, highlight **Reset** and press **ENTER**.

**Note:** If you select one of the factory-set picture modes (**Sports**, **Standard**, or **Movie**) and then change the color temperature mode, the picture mode automatically changes to **Preference** in the **Picture Settings** menu.

### Selecting the lamp mode

You can select either the **High Bright** or **Low Power** lamp mode.

- The **High Bright** mode is useful when additional picture brightness is desired (such as in a bright room).

#### To select the lamp mode:

- 1 Press **MENU** and open the **Video** menu.
- 2 Highlight **Advanced Picture Settings** and press **ENTER**.

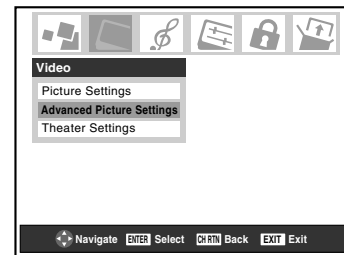

- 3 In the **Lamp Mode** field, select **High Bright** or **Low Power**, whichever you prefer.

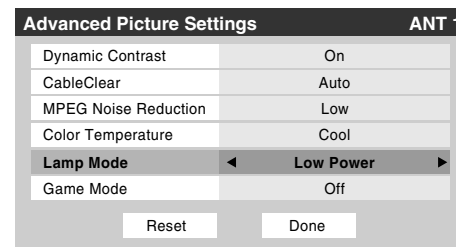

- 4 To save the new settings, highlight **Done** and press **ENTER**. To revert to the factory defaults, highlight **Reset** and press **ENTER**.

**Note:** If you set the lamp mode to **Low Power**, each time you turn on the TV, the lamp will start out in **High Bright** mode but will switch to **Low Power** mode after a short period of time. You may notice a change in screen brightness when this happens. This is normal and is not a sign of malfunction.

## Chapter 6: Using the TV's advanced features

### Using the Game Mode feature

You can use the Game Mode feature for shorter frame delays when playing a video game requiring split-second timing between the on-screen display and input from the controller (such as music creation and high-action games).

**Note:** To use the Game Mode feature, the current video input must be **Video 1**, **Video 2**, **ColorStream HD1**, **ColorStream HD2**, **HDMI 1** or **HDMI 2**. The Game Mode cannot be turned on when any other video input is selected.

#### To turn on Game Mode:

- 1 Press **MENU** and open the **Video** menu.
- 2 Highlight **Advanced picture settings** and press **ENTER**.
- 3 Press **▲** or **▼** to highlight the **Game Mode** field, and then press **◀** or **▶** to select **On**.

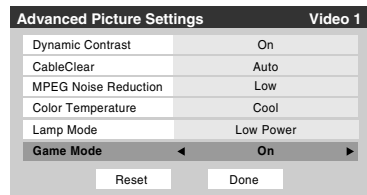

#### To turn off Game Mode:

Select **Off** in step 3 above or change the video input.

You can change the video input in any of the following ways:

- pressing **INPUT** on the remote control (see page 23);
- changing the channel using the Numbers or **CH** / **CH RTN**, **BACK** / **NEXT**, or **FAV▲** / **FAV▼**;
- Turning the TV off and back on again will set Game Mode to **Off**.

### Using the advanced audio settings features

#### Using the SRS WOW™ surround sound feature

WOW™ is a special combination of SRS Labs audio technologies (SRS 3D, SRS FOCUS, and SRS TruBass) that creates a thrilling surround sound experience with deep, rich bass from stereo sound sources. Your TV's audio will sound fuller, richer, and wider.

#### To adjust the WOW™ settings:

- 1 Put the TV in **STEREO** mode (see “Selecting stereo/SAP broadcasts” page 33).
- 2 Press **MENU** and open the **Audio** menu.
- 3 Highlight **Advanced Audio Settings** and press **ENTER**.
- 4 Press **▼** or **▲** to highlight the WOW feature you want to adjust, and then press **◀** or **▶** to adjust the item.

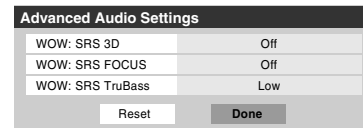

- **WOW: SRS 3D** — To turn the surround sound effect **On** or **Off**.

**Note:** If the broadcast is monaural, the SRS 3D effect will not work.

- **WOW: SRS Focus** — To turn the vocal emphasis effect **On** or **Off**.
- **WOW: SRS TruBass** — To select the desired bass expansion level (**Off**, **Low**, or **High**).

- 5 To save the new settings, highlight **Done** and press **ENTER**. To revert to the factory defaults, highlight **Reset** and press **ENTER**.

WOW, SRS and **●** symbol are trademarks of SRS Labs, Inc. WOW technology is incorporated under license from SRS Labs, Inc.



## Chapter 7: Troubleshooting

### General troubleshooting

Before calling a service technician, please check this entire chapter for a possible cause of the problem and some solutions you can try.

#### Black box on screen

- The Closed Caption feature is set to one of the Text modes (**T1**, **T2**, **T3**, or **T4**). Set the **Closed Caption** feature to **Off** (☞ page 31).

#### TV plays a recorded announcement when LEDs are blinking

- When certain non-standard conditions occur, the LEDs on the TV will blink and the TV will play a recorded “voice announcement” describing the condition (see “LED indications” on page 46 for details).

#### TV stops responding to controls

- If the TV stops responding to the controls on the remote control or TV control panel and you cannot turn off the TV, press and hold the **POWER** button on the TV control panel for 5 or more seconds to reset the TV.

#### Other problems

- If your TV’s problem is not addressed in this Troubleshooting section or the recommended solution has not worked, use the Restore Factory Defaults procedure (☞ page 22).

#### TV will not turn on

- Make sure the power cord is plugged in, and then press **POWER**.
- The remote control batteries may be dead. Replace the batteries or try the control panel buttons.
- If you have recently replaced the lamp unit, make sure the lamp unit and lamp unit door are installed properly (☞ pages 47–49).
- The lamp unit may need to be replaced (☞ pages 47–49). Also see “LED indications” (☞ page 46).
- If the TV is powered off and then quickly on again when the lamp unit is hot, it may take several minutes for the picture to appear on-screen. This is a property of DLP TV lamp technology and is NOT a sign of malfunction. For details, see IMPORTANT NOTICE ABOUT “HOT LAMP RESTART” (☞ page 2).

#### Picture problems

##### General picture problems

- Check the antenna/cable connections (☞ *Installation Guide*).
- Press **INPUT** on the remote control or **INPUT** on the TV control panel and select a valid video input source (☞ page 23). If no device is connected to any of the inputs on the TV, no picture will display when you select that particular input source. For device connection details, see the *Installation Guide*.
- Antenna reception may be poor. Use a highly directional outdoor antenna (if applicable).
- The station may have broadcast difficulties. Try another channel.

- Adjust the picture qualities (☞ page 30).
- If you are using a VCR, make sure **TV/VCR** on the remote control is set correctly (☞ page 9).
- If you have two VCRs connected to your TV, make sure you have not connected the same VCR to the TV’s output and input connections at the same time (☞ *Installation Guide*).
- Do not connect both a standard video cable and an S-video cable to the same set of VIDEO inputs (**VIDEO 1**, or **VIDEO 2**) at the same time (☞ *Installation Guide*).

##### Noisy picture

- If you are watching a tuned analog channel (off-air broadcast or Cable TV), set the **CableClear®/DNR** feature to **AUTO** to reduce visible interference in the TV picture (☞ page 41).

##### Video Input Selection problems

- If the **Input Selection** window does not appear when you press **INPUT** on the remote control or **INPUT** on the TV control panel, press **INPUT** a second time, which will change to the next video input source and display the **Input Selection** window.

##### Cannot view external signals or channel 3 or 4

- If you cannot view signals from external devices connected to **VIDEO 1**, **VIDEO 2**, or **ColorStream®**, or from channels 3 or 4, make sure the **Input Lock** is set to **Off** (☞ page 38).

##### Poor color or no color

- The station may have broadcast difficulties. Try another channel.
- Adjust the **Tint** and/or **Color** (☞ page 30).
- When the **ColorStream®** signal source is active, the **VIDEO OUT** terminal outputs blank video. To receive video from the **VIDEO OUT** signal, a standard video or **S-video IN** terminal must be used instead of the **ColorStream®** connections.

##### Picture brightness changes soon after turning on TV

- If you set the lamp mode to **Low Power**, each time you turn on the TV, the lamp will start out in **High Bright** mode but will switch to **Low Power** mode after a short period of time. You may notice a change in screen brightness when this happens. This is normal and is not a sign of malfunction (☞ page 42).

##### Poor composite or S-video picture

- If the TV is connected to an external A/V device (e.g., DVD player, video game system, set-top box, etc.) try using a **ColorStream** or **HDMI** video connection instead.

##### Picture and sound are out of sync

- As with all products that contain a digital display, in rare instances, when viewing certain content (e.g., television broadcasts, video games, DVDs), you may notice that the sound and picture are slightly out of sync. This phenomenon can be caused by various factors including, without limitation, video processing within the TV, video processing in an attached gaming system, and video processing or different compression rates used by broadcasters in their programming. You may want to try one or more of the following suggestions, which may help to reduce the effect of this phenomenon:

## Chapter 7: Troubleshooting

- If the TV is connected to an A/V receiver that has a programmable audio delay feature, use this feature to help synchronize the sound to the picture.
- If you notice this phenomenon only on certain TV channels, please contact your local broadcast, cable, or satellite provider to inform them of this issue.

### Sound problems

- Check the antenna/cable connections (☞ *Installation Guide*).
- The station may have broadcast difficulties. Try another channel.
- The sound may be muted. Press  $\text{VOL.}$ .
- If you hear no sound, try setting the **MTS** feature to **Stereo** mode (☞ page 33).
- Make sure the Speakers function in the **Audio Setup** menu is set correctly (☞ page 34).
- If you are not receiving a second audio program from a known SAP source, make sure the **MTS** feature is set to **SAP** mode (☞ page 33).
- If you hear audio that seems “incorrect” for the program you are watching (such as music or a foreign language), the SAP mode may be on. Set the **MTS** feature to **Stereo** mode (☞ page 33).
- When using an external audio amplifier, if you connect the amplifier to the **VAR. AUDIO OUT** terminals, the volume of the TV and amplifier must be set above 0 or you will not hear any sound (☞ *Installation Guide*).

### Remote control problems

- Make sure the remote control is set to the correct device mode (☞ pages 9–10).
- Remove all obstructions between the remote control and the TV.
- The remote control batteries may be dead. Replace the batteries (☞ page 7).
- Your TV remote control may not operate certain features on your external device. Refer to the owner’s manual for your other device to determine its available features. If your TV remote control does not operate a specific feature on another device, use the remote control that came with the device (☞ pages 9–13).
- If the TV still does not act as expected, use the Restore Factory Defaults procedure (☞ page 22).

### Channel tuning problems

- Make sure the remote control is set to the correct device mode (☞ page 8).
- The channel may have been erased from the channel memory by the **Channel Add/Delete** feature. Add the channel to the channel memory (☞ page 17).
- The channel may be blocked by the **Channels Block** feature. Unblock the channel (☞ page 37).
- If you are unable to tune digital channels, check the antenna configuration (☞ page 16). If you are still unable to tune digital channels, clear all channels from the channel list (☞ page 18) and reprogram channels into the channel memory (☞ page 17). If you are still unable to tune digital channels, use the Restore Factory Defaults procedure (☞ page 22). Also see “TV stops responding to controls” and “Other problems” (☞ page 44).

### Closed caption problems

- If the program or video you selected is not closed-captioned, no captions will display on-screen (☞ page 31).
- If text is not available, a black rectangle may appear on-screen. If this happens, turn off the closed caption feature (☞ page 31).
- A closed caption signal may not display correctly in the following situations: a) when a videotape has been dubbed; b) when the signal reception is weak; or c) when the signal reception is nonstandard (☞ page 31).

### Rating blocking (V-Chip) problems

- If you forget your PIN code: While the PIN code entering screen is displayed, press  $\text{RECALL}$  four times within 5 seconds. The PIN code you previously stored will be cleared (☞ page 35).
- The V-Chip feature is available for the U.S. V-Chip system only (☞ page 36).

## Chapter 7: Troubleshooting

### LED indications

The yellow blue and red/green LED lights on the TV (at the bottom center of the TV) indicate the TV's status, as described below:

**Note:** If the TV loses A/C power (e.g., a power outage occurs or the power cord is unplugged), when power is restored, the yellow LED will blink while the TV is booting until the remote control is usable. This is normal and is not a sign of malfunction.

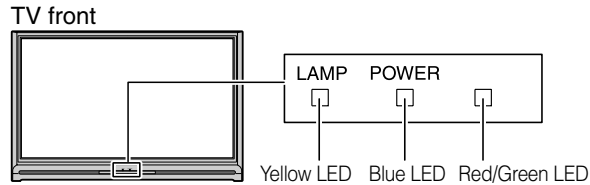

#### “Voice announce” feature

When certain non-standard conditions occur, the LEDs on the TV will blink and the TV will play a recorded “voice announcement” describing the condition (see the table below for the specific conditions that include a voice announcement). To repeat the voice announcement and hear additional information, press the MENU button on the TV while the LEDs are blinking.

LED Indication	Condition	Solution	Voice announce
1) <b>Blue is ON (solid).</b>	The TV is operating properly.	–	–
2) <b>Yellow blinks.</b>	In LPS mode (standby with Quick Restart ON).	See “Setting the Quick Restart™ feature” (page 20).	–
3) <b>Blue is ON (solid).</b> Yellow blinks.	The lamp is not working properly.	The TV will automatically try to restart itself eight times (see item #4). <b>Note:</b> If the TV is powered off and then quickly on again when the lamp unit is hot, it may take several minutes for the picture to appear on-screen. This is a property of DLP TV lamp technology and is NOT a sign of malfunction. For details, see “Setting the Quick Restart™ feature” and “IMPORTANT NOTICE ABOUT HOT LAMP RESTART” (page 21).	–
4) <b>Yellow is ON (solid).</b> Red blinks.	The lamp is not working properly after the eighth automatic restart (see item #3).	Turn the TV OFF and then ON again. If the problem persists, contact Consume Solutions at 1-800-631-3811.	“Lamp not working”
5) <b>Yellow is ON (solid).</b>	The lamp unit door is not seated properly.	Turn OFF the TV and unplug the power cord. Review “Lamp unit replacement and care” in Chapter 8 to ensure that the lamp door is installed securely.	“Lamp door is open.”
6) <b>Red blinks.</b>	Fan stopped (light engine).	Turn OFF the TV and unplug the power cord. Plug the power cord in again and turn ON the TV.	“Fan stopped.”
7) <b>Blue is ON (solid).</b> Green blinks.	Fan stopped (POD).		“Fan stopped.”
8) <b>Blue blinks slowly.</b>	Abnormal operation of BUS line.		–
9) <b>Blue blinks quickly.</b>	Power Protect Detection.		–
10) <b>Blue blinks quickly.</b> Red blinks.	The color wheel has stopped.		“Color wheel stopped.”
11) <b>Blue blinks quickly.</b> Yellow blinks. Red blinks.	An abnormal temperature increase has occurred.	Turn OFF the TV. Check to make sure all slots and openings in the TV cabinet are not covered, blocked, or dusty. Turn ON the TV again.	“Temperature warning.”

If, after trying solutions, the problem still exists:

- In the U.S., call TACP Consumer Solutions at 1-800-631-3811.
- In Canada, locate the nearest Toshiba authorized service depot by directing your web browser to [www.toshiba.ca](http://www.toshiba.ca); click “Home Entertainment,” and then click “Support.”

## Chapter 8: Appendix

### Lamp unit replacement and care

#### Replacing the lamp unit (User-replaceable component)



#### **WARNING: RISK OF ELECTRIC SHOCK!**



**TO REDUCE THE RISK OF ELECTRIC SHOCK, NEVER REMOVE TV COVERS, EXCEPT AS SPECIFIED HEREIN. REFER ALL SERVICING NOT SPECIFIED IN THIS MANUAL TO QUALIFIED SERVICE PERSONNEL.** Failure to follow this WARNING may result in death or serious injury.

The light source for this TV is a mercury lamp with internal atmospheric pressure that increases during use. The lamp has a limited service life that varies depending on product use and user settings.

As is generally the case with all projection TVs that use projection lamps as a light source, the brightness of the lamp in this TV may vary somewhat over the expected service life and will generally decrease over time. Because of the many variables that can affect the useful service life of the lamp, your experience may vary from other users.

**Note :** *The lamp is warranted only for the periods and to the extent set forth in the Limited Warranty applicable to this set. See "Limited United States Warranty" (page 51) or "Limited Canada Warranty" (page 52), as applicable.*

#### **If you use the lamp beyond its service life:**

- you may notice a reduction in the colors and/or brightness of the picture; and
- the strength of the quartz glass in the lamp will be reduced and the lamp may rupture (often making a loud noise when this happens). If the lamp ruptures, the TV will not operate until the lamp unit is replaced.



#### **CAUTION: Always handle the lamp unit with care.**

The lamp unit in this TV was designed for safe replacement by consumers; however, if the lamp unit is subjected to intentional abuse (such as excessive mechanical abuse or handling by children or pets), the unit may break, exposing sharp edges or pinch points.

### When to replace the lamp unit

#### You should replace the lamp unit:

- if the picture darkens and/or colors fade;
- if the screen (lamp) does not light (**LED indication #4**, page 46); or
- if you hear a loud noise and the picture goes black, which may indicate a lamp rupture (**LED indication #4**, page 46).

#### To obtain a replacement lamp unit:

##### In the U.S.

*In warranty:* Visit [www.tacp.toshiba.com/service](http://www.tacp.toshiba.com/service) or call toll-free 1-800-631-3811.

*Out of warranty:* Visit [www.ceaccessories.toshiba.com](http://www.ceaccessories.toshiba.com) or consult your consumer electronics dealer.

##### In Canada

Locate a Toshiba parts distributor by visiting [www.toshiba.ca](http://www.toshiba.ca). Click "Home Entertainment" and then click "Support."

**Always replace the lamp unit with the model currently recommended by Toshiba.**

**For more information, please contact us at the telephone numbers listed above, or visit the websites listed above, as applicable.**

**Using any lamp other than those recommended by Toshiba may cause damage to the TV and/or lamp. SUCH DAMAGE IS NOT COVERED UNDER YOUR TOSHIBA WARRANTY.**

**Chapter 8: Appendix**

**How to replace the lamp unit**



**WARNING: RISK OF ELECTRIC SHOCK!**



TO REDUCE THE RISK OF ELECTRIC SHOCK, NEVER REMOVE TV COVERS, EXCEPT AS SPECIFIED HEREIN. REFER ALL SERVICING NOT SPECIFIED IN THIS MANUAL TO QUALIFIED SERVICE PERSONNEL. Failure to follow this WARNING may result in death or serious injury.

**Required tools:**

- Manual screwdrivers (Phillips and slotted)
- Soft, lint-free gloves

- 1 Turn off the TV and unplug the power cord.



**WARNING: Eye damage may result from directly viewing the light produced by this lamp.**

Always turn off the TV and unplug the power cord before opening the lamp unit door.

- 2 **STOP!** Allow the lamp to cool for at least one (1) hour before replacing it.



**CAUTION: HOT SURFACE!**



Touching the lamp before it has cooled will result in severe burns. ALLOW THE LAMP TO COOL FOR AT LEAST ONE (1) HOUR BEFORE REPLACING IT.

- 3 On the lamp unit door on the back of the TV, loosen the screw by using manual screwdriver, and then remove the lamp unit door.

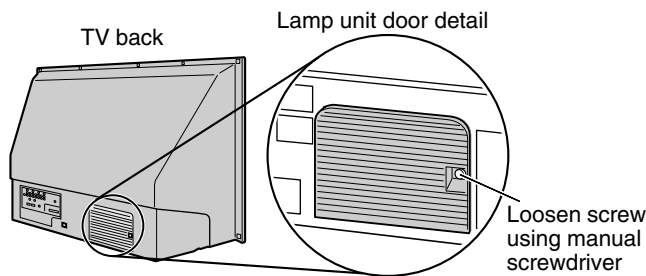

- 4 Using a manual Phillips screwdriver, loosen the two screws on the lamp unit.

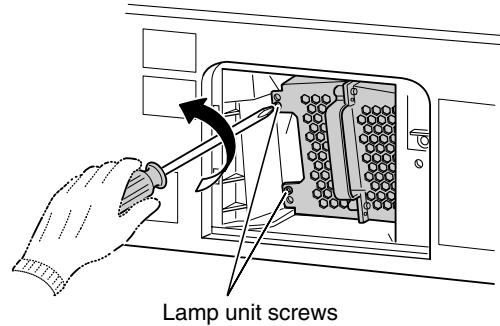

**WARNING: RISK OF ELECTRIC SHOCK!**



The lamp unit door is provided with an interlock to reduce the risk of electric shock and excessive ultraviolet radiation. **Never defeat its purpose or attempt to service without removing the lamp unit door completely.** Failure to follow this WARNING may result in death or serious injury.

- 5 Grasp the lamp unit handle and gently pull the lamp unit straight out of the TV. Set the old lamp unit aside (see "Disposing of the used lamp unit" on page 49).

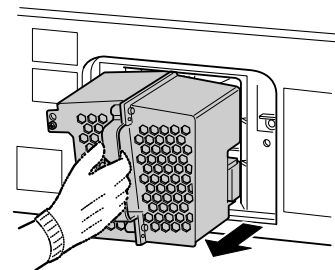

**NOTE:** Wear soft, lint-free gloves when replacing the lamp unit.

- 6 Carefully insert the new lamp unit straight into the TV until it is fully seated.

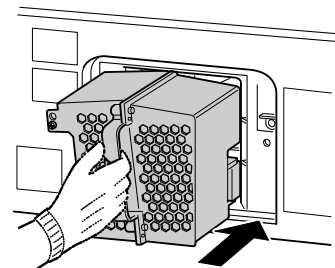



**Chapter 8: Appendix**

**Notes:**

- Never subject the lamp unit to excessive shock.
- Never touch the lamp unit glass or otherwise get it dirty. Doing so may affect the image quality and reduce the service life of the lamp. See "Cleaning the lamp unit glass" below.

**CLEANING THE LAMP UNIT GLASS**

If you accidentally touch the lamp unit glass or otherwise get it dirty, wipe it with a lint-free lens cleaning cloth (such as a cloth for cleaning camera lenses or eyeglasses).



**CAUTION: NEVER clean a hot lamp with any type of flammable liquid or aerosol cleaning agent.** Many ordinary cleaning agents (such as glass cleaners) contain chemicals that may be flammable at certain temperatures. If the lamp unit is not allowed to cool for at least one (1) hour, such chemicals may ignite.

- 7** Using a manual phillips screwdriver, tighten the two lamp unit screws.

**Note:** Hand-tighten only. Do not use an electric screwdriver.

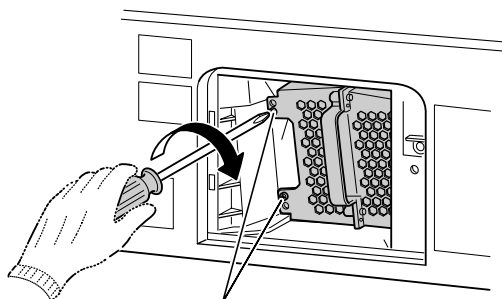

Lamp unit screws  
(use manual Phillips screwdriver only)



**NOTE :** Make sure the lamp unit and screws are installed securely; otherwise, the TV may not turn on and the lamp life may be shortened.

- 8** Reattach the lamp unit door, making sure to insert the hooks on the left side of the lamp unit door inside the opening in the TV cabinet.

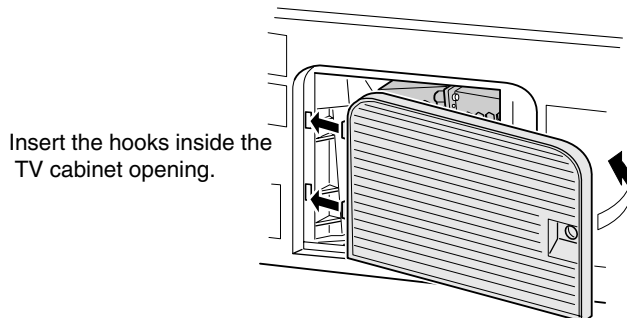

Insert the hooks inside the TV cabinet opening.

Lamp unit door

- 9** Replace the screw and tighten using a manual screwdriver.

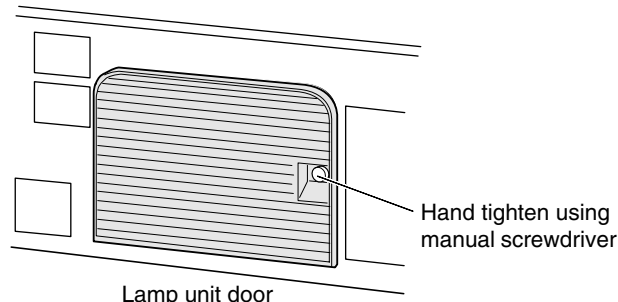

Lamp unit door



**NOTE:** Make sure the lamp unit door is installed securely; otherwise, the TV may not turn on.

- 10** Plug in the power cord and turn on the TV. After the initial warmup period (which may take several seconds for full picture brightness), the TV should operate normally. If any of the following conditions exist, turn off the TV, unplug the power cord, and repeat steps 1–9 to ensure that the lamp unit and lamp unit door are installed correctly:

- No picture
- Dark picture
- TV will not turn on

If, after repeating steps 1–9, the problem still exists:

- In the U.S., call TACP consumer solutions at 1-800-631-3811.
- In Canada, locate the nearest Toshiba authorized service depot by directing your web browser to [www.toshiba.ca](http://www.toshiba.ca); click "Home Entertainment," and then click "Support."

**Disposing of the used lamp unit**

- Place the used lamp unit in the empty box from the new unit.
- Keep the lamp unit out of reach of children and pets.



**CAUTION: Always handle the lamp unit with care.**

The lamp unit in this TV was designed for safe replacement by consumers; however, if the lamp unit is subjected to intentional or accidental abuse (such as excessive mechanical abuse or handling by children or pets), the unit may break, exposing sharp edges or pinch points.

- Dispose of the used lamp unit by the approved method for your area.



**NOTE :** The lamp unit contains mercury. Disposal of mercury may be regulated due to environmental considerations. For disposal or recycling information, contact your local authorities or the Electronic Industries Alliance ([www.eiae.org](http://www.eiae.org)).

## Chapter 8: Appendix

### Specifications

#### Notes:

- **This model complies with the specifications listed below.**
- **Designs and specifications are subject to change without notice.**
- **This model may not be compatible with features and/or specifications that may be added in the future.**

#### Television System

NTSC standard  
 ATSC standard (8VSB)  
 Digital Cable (64 QAM, 256 QAM; in-the-clear, unencrypted\*)

#### Channel Coverage

VHF: 2 through 13  
 UHF: 14 through 69  
 Cable TV: Mid band (A-8 through A-1, A through I)  
 Super band (J through W)  
 Hyper band (AA through ZZ, AAA, BBB)  
 Ultra band (65 through 94, 100 through 135)

#### Power Source

120 V AC, 60 Hz

#### Power Consumption

215 W (average)  
 28 W in standby mode (using a CableCARD™)  
 24 W in standby mode (without a CableCARD™)

#### Audio Power

10 W + 10 W

#### Speaker Type

Main: Two 2-3/8 × 4-3/4 inches (6×12 cm) round  
 Tweeter: Two 1-5/16 inches (33 mm) round

#### Video/Audio Terminals

##### S-VIDEO INPUT:

Y: 1 V(p-p), 75 ohm, negative sync.  
 C: 0.286 V(p-p) (burst signal), 75 ohm

##### VIDEO/AUDIO INPUT:

VIDEO: 1 V(p-p), 75 ohm, negative sync.  
 AUDIO: 150 mV(rms) (30% modulation equivalent, 22 k ohm or greater)

##### ColorStream® (component video) HD INPUT:

VIDEO: Y: 1V(p-p), 75 ohm  
 PR: 0.7 V(p-p), 75 ohm  
 PB: 0.7 V(p-p), 75 ohm  
 Suggested formats: 1080i, 480p, 480i, 720p  
 AUDIO: 150 mV(rms), 22 k ohm or greater

##### HDMI™ INPUT:

HDMI compliant (type A connector)  
 HDCP compliant  
 E-EDID\*\* compliant  
 Suggested formats: 1080i, 480p, 480i, 720p  
 HDMI Audio: 2-channel PCM; 32/44.1/48 kHz sampling frequency; 16/20/24 bits per sample

##### VIDEO/AUDIO OUTPUT (also for recording):

VIDEO: 1 V(p-p), 75 ohm, negative sync.  
 AUDIO: 150 mV(rms) (30% modulation equivalent, 2.2 k ohm or less)

##### VARIABLE AUDIO OUTPUT:

0–300 mV(rms) (30% modulation equivalent, 2.2 k ohm or less)

##### DIGITAL AUDIO OUTPUT:

Optical type

#### Dimensions

50HM66: Width: 47-3/16 inches (1,199 mm)  
 Height: 30-11/16 inches (780 mm)  
 Depth: 16-5/8 inches (422 mm)  
 56HM66: Width: 52-3/8 inches (1,330 mm)  
 Height: 33-3/4 inches (857 mm)  
 Depth: 18-3/8 inches (467 mm)

#### Weight

50HM66: 64 lbs (29.0 kg)  
 56HM66: 72 lbs (32.7 kg)

#### Operating conditions

Temperature: 41°F–95°F (5°C–35°C)  
 Humidity: 20–80% (no moisture condition)

#### Supplied Accessories

- Remote control with two size “AAA” batteries
- Dual-wand IR blaster cable
- Installation Guide
- Operating Guide (this book)

#### Optional Stands

50HM66: ST 5066  
 56HM66: ST 5666

\* Encrypted channels can be viewed on this TV using a CableCARD™ (see *Installation Guide*).

\*\* E-EDID = Enhanced-Extended Display Identification



## Chapter 8: Appendix

### Limited United States Warranty

#### for DLP™ Television Models

Toshiba America Consumer Products, L.L.C. ("TACP") makes the following limited warranties to original consumers in the United States.

**THESE LIMITED WARRANTIES EXTEND TO THE ORIGINAL CONSUMER PURCHASER OR ANY PERSON RECEIVING THIS DLP™ TELEVISION AS A GIFT FROM THE ORIGINAL CONSUMER PURCHASER AND TO NO OTHER PURCHASER OR TRANSFEREE.**

**DLP™ TELEVISIONS PURCHASED IN THE U.S.A. AND USED ANYWHERE OUTSIDE OF THE U.S.A., INCLUDING, WITHOUT LIMITATION, CANADA AND MEXICO, ARE NOT COVERED BY THESE WARRANTIES.**

**DLP™ TELEVISIONS PURCHASED ANYWHERE OUTSIDE OF THE U.S.A., INCLUDING, WITHOUT LIMITATION, CANADA AND MEXICO, AND USED IN THE U.S.A., ARE NOT COVERED BY THESE WARRANTIES.**

#### Limited One (1) Year Warranty on Parts and Labor

TACP warrants this DLP™ Television and its parts against defects in materials or workmanship for a period of one (1) year after the date of original retail purchase. **DURING THIS PERIOD, TACP WILL, AT TACP'S OPTION, REPAIR OR REPLACE A DEFECTIVE PART WITH A NEW OR REFURBISHED PART WITHOUT CHARGE TO YOU FOR PARTS OR LABOR.** During this period, TACP Authorized Service Station personnel will come to your home when warranty service is required. Depending on the type of repair required, the service will either be performed in your home or the DLP™ Television will be taken to a TACP Authorized Service Station for repair and returned to your home at no cost to you.

#### Limited One (1) Year Warranty on Lamp Unit

TACP warrants the original lamp unit contained in this DLP™ Television against defects in materials or workmanship for a period of one (1) year after the date of original retail purchase. **DURING THIS PERIOD, TACP WILL, AT TACP'S OPTION, EXCHANGE A DEFECTIVE LAMP UNIT WITH A NEW OR REFURBISHED LAMP UNIT WITHOUT CHARGE TO YOU. LABOR CHARGES FOR LAMP UNIT REPLACEMENT ARE YOUR RESPONSIBILITY AND ARE NOT COVERED UNDER THIS WARRANTY.** The lamp unit is a user-replaceable component.

#### Rental Units

The warranty for DLP™ Television rental units begins on the date of the first rental or thirty (30) days after the date of shipment to the rental firm, whichever comes first.

#### Limited Warranty for Commercial Units

TACP warrants DLP™ Televisions, including the lamp units contained therein, that are sold and used for commercial purposes as follows: all parts are warranted against defects in materials or workmanship for a period of ninety (90) days after the date of original retail purchase. **DURING THIS PERIOD, TACP WILL, AT TACP'S OPTION, REPAIR OR REPLACE A DEFECTIVE PART WITH A NEW OR REFURBISHED PART WITHOUT CHARGE TO YOU.**

#### Owner's Manual and Product Registration

Read this owner's manual thoroughly before operating this DLP™ television.

Complete and mail the enclosed product registration card or register your DLP™ Television online at [www.tacp.toshiba.com/service](http://www.tacp.toshiba.com/service) as soon as possible. By registering your DLP™ Television you will enable TACP to bring you new products specifically designed to meet your needs and help us to contact you in the unlikely event a safety notification is required under the Consumer Product Safety Act. Failure to register your product does not diminish your warranty rights.

#### Your Responsibility

THE ABOVE WARRANTIES ARE SUBJECT TO THE FOLLOWING CONDITIONS:

- (1) You must retain your original bill of sale or provide other proof of purchase.
- (2) All warranty servicing of this DLP™ Television must be performed by an Authorized TACP Service Station.
- (3) The warranties from TACP are effective only if this DLP™ Television is purchased and operated in the Continental U.S.A. or Puerto Rico.
- (4) Labor service charges for set installation, setup, adjustment of customer controls, and installation or repair of antenna systems are not covered by this warranty. Reception problems caused by inadequate antenna systems, misaligned satellite dishes, cable television distribution, VCRs, DVD players/recorders, personal computer level IEEE1394 devices, and any other connected signal source device are your responsibility.
- (5) Warranties extend only to defects in materials or workmanship as limited above, and do not extend to any DLP™ Television or parts that have been lost or discarded by you or to damage to the DLP™ Television or parts caused by fires, misuse, accident, Acts of God (such as lightning or fluctuations in electric power), improper installation, improper maintenance, or use in violation of instructions furnished by TACP; use or malfunction through simultaneous use of this DLP™ Television and connected equipment; or to units that have been modified or had the serial number removed, altered, defaced, or rendered illegible.

#### How to Obtain Warranty Service

If, after following all of the operating instructions in this manual and reviewing the section titled "Troubleshooting," you find that service is needed:

- (1) To find the nearest TACP Authorized Service Station, visit TACP's website at [www.tacp.toshiba.com/service](http://www.tacp.toshiba.com/service) or contact TACP's Consumer Solution Center toll free at 1-800-631-3811.
- (2) You must present your original bill of sale or other proof of purchase to the TACP Authorized Service Station.

**For additional information, visit TACP's web site:  
[www.tacp.toshiba.com](http://www.tacp.toshiba.com).**

**ALL WARRANTIES IMPLIED BY THE LAW OF ANY STATE OF THE U.S.A., INCLUDING THE IMPLIED WARRANTIES OF MERCHANTABILITY AND FITNESS FOR A PARTICULAR PURPOSE, ARE EXPRESSLY LIMITED TO THE DURATION OF THE LIMITED WARRANTIES SET FORTH ABOVE. WITH THE EXCEPTION OF ANY WARRANTIES IMPLIED BY THE LAW OF ANY STATE OF THE U.S.A. AS HEREBY LIMITED, THE FOREGOING WARRANTY IS EXCLUSIVE AND IN LIEU OF ALL OTHER WARRANTIES, GUARANTEES, AGREEMENTS, AND SIMILAR OBLIGATIONS OF TACP WITH RESPECT TO THE REPAIR OR REPLACEMENT OF ANY PARTS. IN NO EVENT SHALL TACP BE LIABLE FOR CONSEQUENTIAL OR INCIDENTAL DAMAGES (INCLUDING, BUT NOT LIMITED TO, LOST PROFITS, BUSINESS INTERRUPTION, OR MODIFICATION OR ERASURE OF RECORDED DATA CAUSED BY USE, MISUSE OR INABILITY TO USE THIS DLP™ TELEVISION).**

No person, agent, distributor, dealer, or company is authorized to change, modify, or extend the terms of these warranties in any manner whatsoever. The time within which an action must be commenced to enforce any obligation of TACP arising under the warranty or under any statute or law of the United States or any state thereof is hereby limited to ninety (90) days from the date you discover, or should have discovered, the defect. This limitation does not apply to implied warranties arising under the law of any state of the U.S.A.

**THIS WARRANTY GIVES YOU SPECIFIC LEGAL RIGHTS AND YOU MAY ALSO HAVE OTHER RIGHTS WHICH MAY VARY FROM STATE TO STATE IN THE U.S.A. SOME STATES OF THE U.S.A. DO NOT ALLOW LIMITATIONS ON THE DURATION OF AN IMPLIED WARRANTY, WHEN AN ACTION MAY BE BROUGHT, OR THE EXCLUSION OR LIMITATION OF INCIDENTAL OR CONSEQUENTIAL DAMAGES. THEREFORE, THE ABOVE PROVISIONS MAY NOT APPLY TO YOU UNDER SUCH CIRCUMSTANCES.**

05

## Chapter 8: Appendix

### Limited Canada Warranty

#### for DLP™ Television Models

Toshiba of Canada Limited ("TCL") makes the following limited warranties to original consumers in Canada.

THESE LIMITED WARRANTIES EXTEND TO THE ORIGINAL CONSUMER PURCHASER OR ANY PERSON RECEIVING THIS DLP™ TELEVISION AS A GIFT FROM THE ORIGINAL CONSUMER PURCHASER AND TO NO OTHER PURCHASER OR TRANSFEREE. PRODUCTS PURCHASED IN THE U.S.A. AND USED IN CANADA ARE NOT COVERED BY THESE WARRANTIES. PRODUCTS PURCHASED IN CANADA AND USED IN THE U.S.A. ARE NOT COVERED BY THESE WARRANTIES.

#### Limited One (1) Year Warranty on Parts and Labor\*

TCL warrants this DLP™ television and its parts against defects in materials or workmanship for a period of one (1) year after the date of original retail purchase. DURING THIS PERIOD, TCL WILL, AT TCL'S OPTION, REPAIR OR REPLACE A DEFECTIVE PART WITH A NEW OR REFURBISHED PART WITHOUT CHARGE TO YOU FOR PARTS OR LABOR. TCL Authorized Service Depot personnel will come to your home when warranty service is required. Depending on the type of repair required, either the service will be performed in your home or the set will be taken to the TCL Authorized Service Depot for repair and returned to your home at no cost to you. IN-HOME SERVICE ONLY APPLIES WITHIN 100 KILOMETERS OF AN AUTHORIZED TCL SERVICE DEPOT.

#### Limited One (1) Year Warranty on Lamp Unit\*

TCL warrants the lamp unit in this DLP™ television against defects in materials or workmanship for a period of one (1) year after the date of original retail purchase. DURING THIS PERIOD, TCL WILL, AT TCL'S OPTION, EXCHANGE A DEFECTIVE LAMP UNIT WITH A NEW OR REFURBISHED LAMP UNIT WITHOUT CHARGE TO YOU. LABOR CHARGES FOR LAMP UNIT REPLACEMENT ARE NOT COVERED UNDER WARRANTY. The lamp unit is a user-replaceable component.

#### Rental Units

The warranty for rental units, including the lamp units contained therein, begins with the date of first rental or thirty (30) days from the date of shipment to the rental firm, whichever comes first.

#### \*Limited Warranty for Commercial Units

TCL warrants DLP™ televisions, including the lamp units contained therein, sold and used for commercial purposes as follows: all parts are warranted against defects in materials or workmanship for a period of ninety (90) days after the date of original purchase. DURING THIS PERIOD, TCL WILL, AT TCL'S OPTION, REPAIR OR REPLACE A DEFECTIVE PART WITH A NEW OR REFURBISHED PART WITHOUT CHARGE TO YOU. ON-SITE SERVICE ONLY APPLIES WITHIN 100 KILOMETERS OF AN AUTHORIZED TCL SERVICE DEPOT.

#### Owner's Manual and Product Registration

Read this owner's manual thoroughly before operating this DLP™ television.

Register your product online at [www.toshiba.ca](http://www.toshiba.ca) as soon as possible. By registering your product you will enable TCL bring you new products specifically designed to meet your needs and help us to contact you in the unlikely event a safety notification is required under the Consumer Product Safety Act. Failure to register your product does not diminish your warranty rights.

#### Your Responsibility

THE ABOVE WARRANTIES ARE SUBJECT TO THE FOLLOWING CONDITIONS:

- (1) You must provide your bill of sale or other proof of purchase.
- (2) All warranty servicing of this DLP™ television must be performed by an Authorized TCL Service Depot.
- (3) These warranties from TCL are effective only if the DLP™ television is purchased in Canada from an authorized TCL dealer and operated in Canada.
- (4) Labor charges for installation, setup, adjustment of customer controls, and installation or repair of antenna systems are not covered by these warranties. Reception problems caused by inadequate antenna systems are your responsibility.
- (5) Warranties extend only to defects in materials or workmanship as limited above, and do not extend to any DLP™ television or parts that have been lost or discarded by you or to damage to the television or parts caused by fires, misuse, accident, Acts of God (such as lightning or fluctuations in electric power), improper installation, improper maintenance, or use in violation of instructions furnished by TCL; use or malfunction through simultaneous use of this product and connected equipment; or to units that have been modified or had the serial number removed, altered, defaced, or rendered illegible.

#### How to Obtain Warranty Services

If, after following all of the operating instructions in this manual and checking the "Troubleshooting" section, you find that service is needed:

- (1) To find the nearest TCL Authorized Service Depot, visit TCL's web site at [www.toshiba.ca](http://www.toshiba.ca).
- (2) Present your bill of sale or other proof of purchase to the Authorized Service Depot.

**For additional information, visit TCL's web site:  
[www.toshiba.ca](http://www.toshiba.ca)**

ALL WARRANTIES IMPLIED BY THE LAW OF ANY PROVINCE OF CANADA, INCLUDING THE IMPLIED WARRANTIES OF MERCHANTABILITY AND FITNESS FOR A PARTICULAR PURPOSE, ARE EXPRESSLY LIMITED TO THE DURATION OF THE LIMITED WARRANTIES SET FORTH ABOVE. WITH THE EXCEPTION OF ANY WARRANTIES IMPLIED BY THE LAW OF ANY PROVINCE OF CANADA AS HEREBY LIMITED, THE FOREGOING WARRANTY IS EXCLUSIVE AND IN LIEU OF ALL OTHER WARRANTIES, GUARANTEES, AGREEMENTS, AND SIMILAR OBLIGATIONS OF TCL WITH RESPECT TO THE REPAIR OR REPLACEMENT OF ANY PARTS. IN NO EVENT SHALL TCL BE LIABLE FOR CONSEQUENTIAL OR INCIDENTAL DAMAGES (INCLUDING, BUT NOT LIMITED TO, LOST PROFITS, BUSINESS INTERRUPTION, OR MODIFICATION OR ERASURE OF RECORDED DATA CAUSED BY USE, MISUSE, OR INABILITY TO USE THIS PRODUCT).

No person, agent, distributor, dealer, or company is authorized to change, modify, or extend the terms of these warranties in any manner whatsoever. The time within which action must be commenced to enforce any obligation of TCL arising under this warranty or under any law of Canada or of any province thereof is hereby limited to 90 days from the date you discover, or should have discovered, the defect. This limitation does not apply to implied warranties arising under the law of any province of Canada.

THIS WARRANTY GIVES YOU SPECIFIC LEGAL RIGHTS, AND YOU MAY ALSO HAVE OTHER RIGHTS, WHICH MAY VARY FROM PROVINCE TO PROVINCE IN CANADA. SOME PROVINCES OF CANADA DO NOT ALLOW LIMITATIONS ON THE DURATION OF AN IMPLIED WARRANTY, LIMITATIONS ON THE TIME WITHIN WHICH AN ACTION MAY BE BROUGHT, OR THE EXCLUSION OR LIMITATION OF INCIDENTAL OR CONSEQUENTIAL DAMAGES; THEREFORE, THE ABOVE LIMITATIONS OR EXCLUSIONS MAY NOT APPLY TO YOU UNDER SUCH CIRCUMSTANCES.

## Chapter 8: Appendix

A copy of the GPL source code in this product may be obtained by contacting Toshiba Consumer Solutions at (800)631-3811. There will be a charge to cover the costs of providing the source code.

A copy of the LGPL source code in this product may be obtained by contacting Toshiba Consumer Solutions at (800)631-3811. There will be a charge to cover the costs of providing the source code.

USB Protocol Copyright © 2005 The NetBSD Foundation, Inc. All rights reserved.

Redistribution and use in source and binary forms, with or without modification, are permitted provided that the following conditions are met:

- (1) Redistributions of source code must retain the above copyright notice, this list of conditions and the following disclaimer.
- (2) Redistributions in binary form must reproduce the above copyright notice, this list of conditions and the following disclaimer in the documentation and/or other materials provided with the distribution.
- (3) Neither the name of The NetBSD Foundation nor the names of its contributors may be used to endorse or promote products derived from this software without specified prior written permission.

**THIS SOFTWARE IS PROVIDED BY THE NETBSD FOUNDATION, INC. AND CONTRIBUTORS "AS IS" AND ANY EXPRESS OR IMPLIED WARRANTIES, INCLUDING, BUT NOT LIMITED TO, THE IMPLIED WARRANTIES OF MERCHANTABILITY AND FITNESS FOR A PARTICULAR PURPOSE ARE DISCLAIMED. IN NO EVENT SHALL THE FOUNDATION OR CONTRIBUTORS BE LIABLE FOR ANY DIRECT, INDIRECT, INCIDENTAL, SPECIAL, EXEMPLARY, OR CONSEQUENTIAL DAMAGES (INCLUDING, BUT NOT LIMITED TO, PROCUREMENT OF SUBSTITUTE GOODS OR SERVICES; LOSS OF USE, DATA, OR PROFITS; OR BUSINESS INTERRUPTION) HOWEVER CAUSED AND ON ANY THEORY OF LIABILITY, WHETHER IN CONTRACT, STRICT LIABILITY, OR TORT (INCLUDING NEGLIGENCE OR OTHERWISE) ARISING IN ANY WAY OUT OF THE USE OF THIS SOFTWARE, EVEN IF ADVISED OF THE POSSIBILITY OF SUCH DAMAGE.**

This product includes software developed by the OpenSSL Project for use in the OpenSSL Toolkit (<http://www.openssl.org>).

This product includes cryptographic software written by Eric Young ([ey@cryptsoft.com](mailto:ey@cryptsoft.com)).

OpenSSL 0.9.7d Copyright © 1998-2000 the OpenSSL Project. All Rights reserved. Redistribution and use in source and binary forms, with or without modification, are permitted provided that the following conditions are met:

- (1) Redistributions of source code must retain the above copyright notice, this list of conditions and the following disclaimer.
- (2) Redistributions in binary form must reproduce the above copyright notice, this list of conditions and the following disclaimer in the documentation and/or other materials provided with the distribution.
- (3) All advertising materials mentioning features or use of this software must display the following acknowledgement: This product includes software developed by the OpenSSL Project for use in the OpenSSL Toolkit (<http://openssl.org>).
- (4) The names "OpenSSL Toolkit" and "Open SSL Project" must not be used to endorse or promote products derived from this software without prior written permission. For written permission, please contact [openssl-core@openssl.org](mailto:openssl-core@openssl.org).
- (5) Products derived from this software may not be called "OpenSSL" nor may "Open SSL" appear in their names without prior written permission of the OpenSSL Project.
- (6) Redistributions of any form whatsoever must retain the following acknowledgement: "This product includes software developed by the OpenSSL Project for use in the OpenSSL Toolkit (<http://www.openssl.org>)."

**THIS SOFTWARE IS PROVIDED BY THE OpenSSL PROJECT "AS IS" AND ANY EXPRESSED OR IMPLIED WARRANTIES, INCLUDING, BUT NOT LIMITED TO, THE IMPLIED WARRANTIES OF MERCHANTABILITY AND FITNESS FOR A PARTICULAR PURPOSE ARE DISCLAIMED. IN NO EVENT SHALL THE OpenSSL PROJECT OR CONTRIBUTORS BE LIABLE FOR ANY DIRECT, INDIRECT, INCIDENTAL, SPECIAL, EXEMPLARY, OR CONSEQUENTIAL DAMAGES (INCLUDING, BUT NOT LIMITED TO, PROCUREMENT OF SUBSTITUTE GOODS OR SERVICES; LOSS OF USE, DATA, OR PROFITS; OR BUSINESS INTERRUPTION) HOWEVER CAUSED AND ON ANY THEORY OF LIABILITY, WHETHER IN CONTRACT, STRICT LIABILITY, OR TORT (INCLUDING NEGLIGENCE OR OTHERWISE) ARISING IN ANY WAY OUT OF THE USE OF THIS SOFTWARE, EVEN IF ADVISED OF THE POSSIBILITY OF SUCH DAMAGE.** This product includes cryptographic software written by Eric Young ([ey@cryptsoft.com](mailto:ey@cryptsoft.com)). This product includes software written by Tim Hudson ([tjh@cryptsoft.com](mailto:tjh@cryptsoft.com)).

Copyright © 1995-1998 Eric Young ([ey@cryptsoft.com](mailto:ey@cryptsoft.com)). All Rights reserved. This package is an SSL implementation written by Eric Young ([ey@cryptsoft.com](mailto:ey@cryptsoft.com)). The implementation was written so as to conform with Netscapes SSL. This library is free for commercial and non-commercial use so long as the following conditions are adhered to. The following conditions apply to all code found in this distribution, be it the RC4, RSA, lhash, DES, etc., code; not just the SSL code. The SSL documentation included with this distribution is covered by the same copyright terms except that the holder is Tim Hudson ([tjh@cryptsoft.com](mailto:tjh@cryptsoft.com)). Copyright remains Eric Young's, and as such any Copyright notices in the code are not to be removed. If this package is used in a product, Eric Young should be given attribution as the author of the parts of the library used. This can be in the form of a textual message at program startup or in documentation (online or textual) provided with the package.

Redistribution and use in source and binary forms, with or without modification, are permitted provided that the following conditions are met:

- (1) Redistributions of source code must retain the copyright notice, this list of conditions and the following disclaimer.
- (2) Redistributions in binary form must reproduce the above copyright notice, this list of conditions and the following disclaimer in the documentation and/or other materials provided with the distribution.
- (3) All advertising materials mentioning features or use of this software must display the following acknowledgement: "This product includes cryptographic software written by Eric Young ([ey@cryptsoft.com](mailto:ey@cryptsoft.com)). The word 'cryptographic' can be left out if the routines from the library being used are not cryptographic related."
- (4) If you include any Windows specific code (or derivative thereof) from the apps directory (application code) you must include an acknowledgement: "This product includes software written by Tim Hudson ([tjh@cryptsoft.com](mailto:tjh@cryptsoft.com))."

**THIS SOFTWARE IS PROVIDED BY ERIC YOUNG "AS IS" AND ANY EXPRESS OR IMPLIED WARRANTIES, INCLUDING, BUT NOT LIMITED TO, THE IMPLIED WARRANTIES OF MERCHANTABILITY AND FITNESS FOR A PARTICULAR PURPOSE ARE DISCLAIMED. IN NO EVENT SHALL THE AUTHOR OR CONTRIBUTORS BE LIABLE FOR ANY DIRECT, INDIRECT, INCIDENTAL, SPECIAL, EXEMPLARY, OR CONSEQUENTIAL DAMAGES (INCLUDING, BUT NOT LIMITED TO, PROCUREMENT OF SUBSTITUTE GOODS OR SERVICES; LOSS OF USE, DATA, OR PROFITS; OR BUSINESS INTERRUPTION) HOWEVER CAUSED AND ON ANY THEORY OF LIABILITY, WHETHER IN CONTRACT, STRICT LIABILITY, OR TORT (INCLUDING NEGLIGENCE OR OTHERWISE) ARISING IN ANY WAY OUT OF THE USE OF THIS SOFTWARE, EVEN IF ADVISED OF THE POSSIBILITY OF SUCH DAMAGE.** The license and distribution terms for any publicly available version or derivative of this code cannot be changed, i.e. this code cannot simply be copied and put under another distribution license (including the GNU Public License).

# Index

## A

- Antenna input configuration ..... 16
- Audio quality adjustments ..... 33
- Auto aspect ..... 29
- Auto power off ..... 40

## B

- Back of the TV ..... 6
- Blocking channels ..... 37

## C

- CableClear DNR ..... 41
- CH RTN button ..... 26
- CH  $\wedge$   $\vee$  buttons ..... 26
- Channel Browser Setup ..... 24
- Channel Browser™ ..... 24
- Channel Browser™ banner ..... 25
- Channel Number buttons ..... 26
- Channel programming
  - Automatic programming ..... 17
  - Manually adding and deleting... 17
- Cinema mode ..... 29
- Closed captions ..... 31
- Color temperature ..... 42
- ColorStream HD audio ..... 20

## D

- Defaults, restore TV factory ..... 22
- Digital audio selector ..... 32
- Digital signal meter ..... 21
- DNR (Digital Noise Reduction) ..... 41
- Dynamic contrast ..... 41

## F

- Favorite channels ..... 18
- Features, TV ..... 4
- Front of the TV ..... 5

## H

- HDMI audio mode ..... 20

## I

- INPUT button ..... 23
- Installation, setup ..... 4
- Integrated digital tuning ..... 4

## L

- Labeling video input ..... 23
- Lamp mode ..... 42
- Lamp unit replacement ..... 47
- Language selection ..... 16
- Last mode memory feature ..... 40
- LED indications ..... 46
- LOCKS menu
  - Channels, blocking ..... 37
  - Enable rating blocking ..... 36
  - New PIN code ..... 35
  - Panel lock ..... 39
  - Unlocking programs
    - temporarily ..... 38
  - Video inputs, locking ..... 38
- Locks menu ..... 35

## M

- MPEG noise reduction ..... 41
- MTS feature ..... 33
- MUTE button ..... 32

## O

- Optical audio output format ..... 34

## P

- Picture adjustment ..... 30
- Picture mode ..... 30
- Picture quality ..... 30
- Picture scroll ..... 28
- Picture size selection ..... 27
- POWER button ..... 5

## Q

- Quick Restart™ ..... 20

## R

- RECALL button ..... 40
- Remote control
  - Battery installation ..... 7
  - Device code table ..... 12
  - Effective range ..... 7
  - Functional key chart ..... 10
  - Learning about the buttons ..... 8
  - Programming ..... 11

## S

- SAP sound ..... 33
- Scroll settings ..... 28
- Selecting Menu Language ..... 16
- Side panel control ..... 5
- Sleep timer ..... 39
- Speaker On/Off ..... 34
- Specifications ..... 50
- StableSound® ..... 34
- Stereo sound ..... 33
- SurfLock™ ..... 26
- System status ..... 22

## T

- TheaterWide® picture size ..... 27
- Troubleshooting ..... 44

## V

- V-Chip blocking (Locks menu) ..... 35
- Video input label ..... 23
- Video input lock ..... 38

## W

- Warranty
  - Canada ..... 52
  - U.S. .... 51
- WOW:SRS 3D ..... 43
- WOW:SRS Focus ..... 43
- WOW:SRS TruBass ..... 43

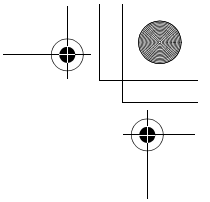
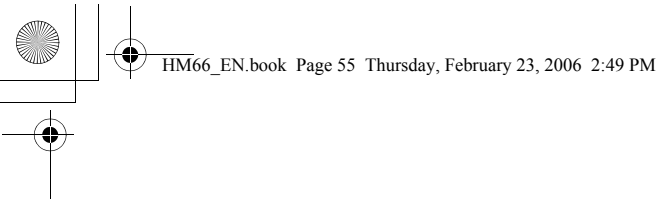

---

# Notes

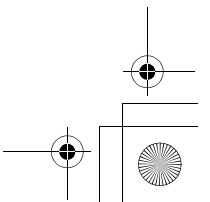
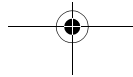
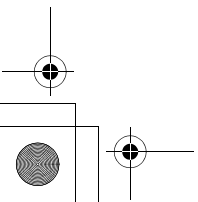
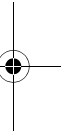
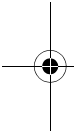

## **TOSHIBA AMERICA CONSUMER PRODUCTS, L.L.C.**

Corporate Headquarters: 82 TOTOWA ROAD, WAYNE, NJ 07470, U.S.A.  
NATIONAL SERVICE DIVISION: 1420-B TOSHIBA DRIVE, LEBANON, TN 37087, U.S.A.

## **TOSHIBA OF CANADA LTD.**

HEAD OFFICE: 191 McNABB STREET, MARKHAM, ONTARIO, L3R 8H2, CANADA – TEL: (905) 470-5400  
SERVICE CENTERS:  
TORONTO: 191 McNABB STREET, MARKHAM, ONTARIO L3R 8H2, CANADA – TEL: (905) 470- 5400  
MONTREAL: 18050 TRANS CANADA, KIRKLAND, QUEBEC, H9J 4A1, CANADA – TEL: (514) 390-7766  
VANCOUVER: 22171 FRASERWOOD WAY, RICHMOND, B.C., V6W 1J5, CANADA – TEL: (604) 303-2500

MANUFACTURED BY  
**TOSHIBA AMERICA CONSUMER PRODUCTS, L.L.C.**

CableClear, ColorStream, StableSound, and TheaterWide are registered trademarks of Toshiba America Consumer Products, L.L.C.  
Channel Browser, SurfLock, and Quick Restart are trademarks of Toshiba America Consumer Products, L.L.C.  
Digital Light Processing™, DLP™ and the DLP™ medallion are trademarks of Texas Instruments.

PRINTED IN USA  
(06-03)

# **TOSHIBA**